

TOSHIBA
Satellite A350/
Satellite A350D series
User's Manual

Copyright

© 2008 by TOSHIBA Corporation. All rights reserved. Under the copyright laws, this manual cannot be reproduced in any form without the prior written permission of TOSHIBA. No patent liability is assumed, with respect to the use of the information contained herein.

TOSHIBA Satellite A350/Satellite A350D series Portable Personal Computer User's Manual

First edition June 2008

Copyright authority for music, movies, computer programs, databases and other intellectual property covered by copyright laws belongs to the author or to the copyright owner. Copyrighted material can be reproduced only for personal use or use within the home. Any other use beyond that stipulated above (including conversion to digital format, alteration, transfer of copied material and distribution on a network) without the permission of the copyright owner is a violation of copyright or author's rights and is subject to civil damages or criminal action. Please comply with copyright laws in making any reproduction from this manual.

Disclaimer

This manual has been validated and reviewed for accuracy. The instructions and descriptions it contains are accurate for the TOSHIBA Satellite A350/Satellite A350D series Portable Personal Computers at the time of this manual's production. However, succeeding computers and manuals are subject to change without notice. TOSHIBA assumes no liability for damages incurred directly or indirectly from errors, omissions or discrepancies between the computer and the manual.

Trademarks

IBM is a registered trademark and IBM PC is a trademark of International Business Machine Corporation.

Intel, Intel Core, Celeron, Centrino and Pentium are registered trademark or trademarks of Intel Corporation.

Microsoft, Windows® and Windows Vista are either registered trademarks or trademarks of Microsoft Corporation.

DirectX, ActiveDesktop, DirectShow, and Windows Media are registered trademarks of Microsoft Corporation.

Adobe and Photoshop are either registered trademarks or trademarks of Adobe system Incorporated in the United States.

Bluetooth™ is a registered trademark owned by its proprietor and used by TOSHIBA under license.

ConfigFree is a trademark of TOSHIBA Corporation,

DVD MovieFactory is trademark of the Ulead System. Inc.

Manufactured under license from Dolby Laboratories.

Dolby and the double-D symbol are trademarks of Dolby Laboratories.

Dolby Home Theater is a trademark of Dolby Laboratories.

ExpressCard is a trademark of PCMCIA

HDMI, the HDMI logo and High-Definition Multimedia Interface are trademarks or registered trademarks of HDMI Licensing LLC.

LabelFlash™ is trademark of YAMAHA Corporation.

Photo CD is a trademark of Eastman Kodak.

Wi-Fi is a registered trademark of the Wi-Fi Alliance.

Memory Stick, Memory Stick PRO, Memory Stick PRO Duo and i.LINK are registered trademarks and i.LINK is a trademark of SONY Corporation.

Secure Digital and SD are trademarks of SD Card Association.

MultiMediaCard and MMC are trademarks of MultiMediaCard Association.

xD-Picture Card is a trademark of FUJIFILM Corporation.

Other trademarks and registered trademarks not listed above may be used in this manual.

Macrovision License of Notice

For DVD Manufacturing License Agreement

This product incorporates copyright protection technology that is protected by U.S. patents and other intellectual property rights, including U.S. Patent Numbers 6,836,549; 6,381,747; 7,050,698; 6,516,132 and 5,583,936. Use of this copyright protection technology must be authorized by Macrovision, and is intended for home and other viewing uses only unless otherwise authorized by Macrovision. Reverse engineering or disassembly is prohibited. The copyright protection technology availability depends on the model you purchased.

Safety instructions

Use the following safety guidelines to help to protect yourself and your computer.

When using your computer



Do not operate your portable computer for an extended period of time with the base resting directly on your body. With extended operation, heat can potentially build up in the base. Allowing sustained contact with the skin could cause discomfort or, eventually, a burn.

- Do not attempt to service the computer yourself. Always follow installation instructions closely.
- Do not carry a battery in your pocket, purse, or other container where metal objects (such as car keys) could short-circuit the battery terminals. The resulting excessive current flow can cause extremely high temperatures and may result in damage from burns.
- Be sure that nothing rests on your AC adaptor's power cable and that the cable is not located where it can be tripped over or stepped on.
- Place the AC adaptor in a ventilated area, such as a desk top or on the floor, when you use it to run the computer or to charge the battery. Do not cover the AC adaptor with papers or other items that will reduce cooling; also, do not use the AC adaptor while it is inside a carrying case.
- Use only the AC adaptor and batteries that are approved for use with this computer. Use of another type of battery or AC adaptor may risk fire or explosion.
- Before you connect the computer to a power source, ensure that the voltage rating of the AC adaptor matches that of the available power source. 115 V/60 Hz in most of North and South America and some Far Eastern countries such as Taiwan. 100 V/50 Hz in eastern Japan and 100 V/60 Hz in western Japan. 230 V/50 Hz in most of Europe, the Middle East, and the Far East.
- If you use an extension cable with your AC adaptor, ensure that the total ampere rating of the products plugged in to the extension cable does not exceed the ampere rating of the extension cable.
- To remove power from the computer, turn it off, remove the battery, and disconnect the AC adaptor from the electrical outlet.
- To help avoid the potential hazard of electric shock, do not connect or disconnect any cables or perform maintenance or reconfiguration of this product during an electrical storm.
- When setting up the computer for work, place it on a level surface.

FCC information

FCC notice "Declaration of Conformity Information"

This equipment has been tested and found to comply with the limits for a Class B digital device, pursuant to part 15 of the FCC rules. These limits are designed to provide reasonable protection against harmful interference in a residential installation. This equipment generates, uses and can radiate radio frequency energy and, if not installed and used in accordance with the instructions, may cause harmful interference to radio communications. However, there is no guarantee that interference will not occur in a particular installation. If this equipment does cause harmful interference to radio or television reception, which can be determined by turning the equipment off and on, the user is encouraged to try to correct the interference by one or more of the following measures:

- Reorient or relocate the receiving antenna.
- Increase the separation between the equipment and receiver.
- Connect the equipment into an outlet on a circuit different from that to which the receiver is connected.
- Consult the dealer or an experienced radio/TV technician for help.



Only peripherals complying with the FCC class B limits may be attached to this equipment. Operation with non-compliant peripherals or peripherals not recommended by TOSHIBA is likely to result in interference to radio and TV reception. Shielded cables must be used between the external devices and the computer's external monitor port, Universal Serial Bus (USB 2.0) ports, i.LINK (IEEE1394) port, HDMI out port and microphone jack. Changes or modifications made to this equipment, not expressly approved by TOSHIBA or parties authorized by TOSHIBA could void the user's authority to operate the equipment.

FCC conditions

This device complies with part 15 of the FCC Rules. Operation is subject to the following two conditions:

1. This device may not cause harmful interference.
2. This device must accept any interference received, including interference that may cause undesired operation.

Contact

Address: TOSHIBA America Information Systems, Inc.
9740 Irvine Boulevard
Irvine, California 92618-1697

Telephone: (949) 583-3000

EU Declaration of Conformity



Supplementary Information: The product complies with the requirements Of the Low Voltage Directive 2006/95/EC, the EMC Directive 2004/108/EC and/or the R&TTE Directive 1999/5/EC."

This product is carrying the CE-Mark in accordance with the related European Directives. Responsible for CE-Marking is TOSHIBA Europe, Hammfelddamm 8, 41460 Neuss, Germany.

VCCI Class B Information

この装置は、情報処理装置等電波障害自主規制協議会（VCCI）の基準に基づくクラスB情報技術装置です。この装置は、家庭環境で使用することを目的としていますが、この装置がラジオやテレビジョン受信機に近接して使用されると、受信障害を引き起こすことがあります。
取扱説明書に従って正しい取り扱いをして下さい。

Canadian regulatory information (Canada only)

This digital apparatus does not exceed the Class B limits for radio noise emissions from digital apparatus as set out in the Radio Interference Regulation of the Canadian Department of Communications.

Note that Canadian Department of Communications (DOC) regulations provide, that changes or modifications not expressly approved by TOSHIBA Corporation could void your authority to operate this equipment.

This Class B digital apparatus meets all requirements of the Canadian Interference-Causng Equipment Regulations.

Cet appareil numérique de la class B respecte toutes les exgences du Règlement sur le matériel brouilleur du Canada.

Modem warning notice

Conformity Statement

The equipment has been approved to [Commission Decision "CTR21"] for pan-European single terminal connection to the Public Switched Telephone Network (PSTN).

However, due to differences between the individual PSTNs provided in different countries/regions the approval does not, of itself, give an unconditional assurance of successful operation on every PSTN network termination point.

In the event of problems, you should contact your equipment supplier in the first instance.

Network Compatibility Statement

This product is designed to work with, and is compatible with the following networks. It has been tested to and found to conform with the additional requirements conditional in EG 201 121.

Germany	ATAAB AN005, AN006, AN007, AN009, AN010 and DE03, 04, 05, 08, 09, 12, 14, 17
Greece	ATAAB AN005, AN006 and GR01, 02, 03, 04
Portugal	ATAAB AN001, 005, 006, 007, 011 and P03, 04, 08, 10
Spain	ATAAB AN005, 007, 012, and ES01
Switzerland	ATAAB AN002
All other countries/regions	ATAAB AN003, 004

Specific switch settings or software setup is required for each network, please refer to the relevant sections of the user guide for more details.

The hookflash (timed break register recall) function is subject to separate national type approvals. It has not been tested for conformity to national type regulations, and no guarantee of successful operation of that specific function on specific national networks can be given.

Japan regulations

Region selection

If you are using the computer in Japan, technical regulations described under Telecommunications Business Law require that you select the Japan region mode. It is illegal to use the modem in Japan with any other selection.

Redial

Up to two redial attempts can be made. If more than two redial attempts are made, the modem will return **Black Listed**. If you are experiencing problems with the Black Listed code, set the interval between redials at one minute or longer.

Japan's Telecommunications Business Law permits up to two redials on analogue telephones, but the redials must be made within a total of three minutes.

The internal modem is approved by the Japan Approvals Institute for Telecommunications Equipment.



認定番号

A05-0413001

A05-0025001

Pursuant to FCC CFR 47, Part 68:

When you are ready to install or use the modem, call your local telephone company and give them the following information:

- The telephone number of the line to which you will connect the modem
- The registration number that is located on the device.

US: AGSMD01BDELPHI

S56MD01B13054

The FCC registration number of the modem will be found on either the device which is to be installed, or, if already installed, on the bottom of the computer outside of the main system label.

- The Ringer Equivalence Number (REN) of the modem, which can vary - for the REN, please refer to the modem's label.

The modem connects to the telephone line by means of a standard jack called the USOC RJ11C.

Type of service

Your modem is designed to be used on standard-device telephone lines. Connection to telephone company-provided coin service (central office implemented systems) is prohibited. Connection to party lines service is subject to state tariffs. If you have any questions about your telephone line, such as how many pieces of equipment you can connect to it, the telephone company will provide this information upon request.

Telephone company procedures

The goal of the telephone company is to provide you with the best service it can. In order to do this, it may occasionally be necessary for them to make changes in their equipment, operations, or procedures. If these changes might affect your service or the operation of your equipment, the telephone company will give you notice in writing to allow you to make any changes necessary to maintain uninterrupted service.

If problems arise

If any of your telephone equipment is not operating properly, you should immediately remove it from your telephone line, as it may cause harm to the telephone network. If the telephone company notes a problem, they may temporarily discontinue service. When practical, they will notify you in advance of this disconnection. If advance notice is not feasible, you will be notified as soon as possible. When you are notified, you will be given the opportunity to correct the problem and informed of your right to file a complaint with the FCC. In the event repairs are ever needed on your modem, they should be performed by TOSHIBA Corporation or an authorized representative of TOSHIBA Corporation.

Disconnection

If you should ever decide to permanently disconnect your modem from its present line, please call the telephone company and let them know of this change.

Fax branding

The Telephone Consumer Protection Act of 1991 makes it unlawful for any person to use a computer or other electronic device to send any message via a telephone fax machine unless such a message clearly contains in a margin at the top or bottom of each transmitted page, or on the first page of the transmission, the date and time it is sent, an identification of the business, other entity or individual sending the message and the telephone number of the sending machine or such business, other entity or individual. In order to program this information into your fax modem, you should complete the setup of your fax software before sending messages.



Use only No. 26 AWG or larger telecommunication line cord.

Instructions for IC CS-03 certified equipment

1. The Industry Canada label identifies certified equipment. This certification means that the equipment meets certain telecommunications network protective, operational and safety requirements as prescribed in the appropriate Terminal Equipment Technical Requirements document(s). The Department does not guarantee the equipment will operate to the user's satisfaction. Before installing this equipment, users should ensure that it is permissible to be connected to the facilities of the local telecommunications company. The equipment must also be installed using an acceptable method of connection.

The customer should be aware that compliance with the above conditions may not prevent degradation of service in some situations. Repairs to certified equipment should be coordinated by a representative designated by the supplier. Any repairs or alterations made by the user to this equipment, or equipment malfunctions, may give the telecommunications company cause to request the user to disconnect the equipment.

Users should ensure for their own protection that the electrical ground connections of the power utility, telephone lines and internal metallic water pipe system, if present, are connected together. This precaution may be particularly important in rural areas.



Users should not attempt to make such connections themselves, but should contact the appropriate electric inspection authority, or electrician, as appropriate.

-
- The user manual of analog equipment must contain the equipment's Ringer Equivalence Number (REN) and an explanation notice similar to the following:

The Ringer Equivalence Number (REN) of the modem can vary - for the REN, please refer to the modem's label.



The Ringer Equivalence Number (REN) assigned to each terminal device provides an indication of the maximum number of terminals allowed to be connected to a telephone interface. The termination on an interface may consist of any combination of devices subject only to the requirement that the sum of the Ringer Equivalence Numbers of all the devices does not exceed 5.

- The standard connecting arrangement (telephone jack type) for this equipment is jack type(s): USOC RJ11C.

The IC registration number of the modem is shown below.

Canada: 4005B-DELPHI
109AH-ML3054

Notes for Users in Australia and New Zealand

Modem warning notice for Australia

Modems connected to the Australian telecoms network must have a valid Austel permit. This modem has been designed to specifically configure to ensure compliance with Austel standards when the country/region selection is set to Australia. The use of other country/region settings while the modem is attached to the Australian PSTN would result in your modem being operated in a non-compliant manner. To verify that the country/region is correctly set, enter the command ATi which displays the currently active setting.

To set the country/region permanently to Australia, enter the following command sequence:

```
AT%TE=1  
ATS133=1  
AT&F  
AT&W  
AT%TE=0  
ATZ
```

Failure to set the modem to the Australia country/region setting as shown above will result in the modem being operated in a non-compliant manner. Consequently, there would be no permit in force for this equipment, with the Telecoms Act 1991 prescribing a penalty of \$12,000 for the connection of non-permitted equipment.

Notes for use of this device in New Zealand

- The grant of a Telepermit for a device in no way indicates Telecom acceptance of responsibility for the correct operation of that device under all operating conditions. In particular the higher speeds at which this modem is capable of operating depend on a specific network implementation which is only one of many ways of delivering high quality voice telephony to customers. Failure to operate should not be reported as a fault to Telecom.
- In addition to satisfactory line conditions a modem can only work properly if:
 - a/ It is compatible with the modem at the other end of the call, and;
 - b/ The application using the modem is compatible with the application at the other end of the call - for example, accessing the Internet requires suitable software in addition to a modem.
- This equipment shall not be used in any manner which could constitute a nuisance to other Telecom customers.
- Some parameters required for compliance with Telecom's PTC Specifications are dependent on the equipment (PC) associated with this modem. The associated equipment shall be set to operate within the following limits for compliance with Telecom Specifications:
 - a/ There shall be no more than 10 call attempts to the same number within any 30 minute period for any single manual call initiation, and;
 - b/ The equipment shall go on-hook for a period of not less than 30 seconds between the end of one attempt and the beginning of the next, and;
 - c/ Automatic calls to different numbers shall be not less than 5 seconds apart.
- Immediately disconnect this equipment should it become physically damaged, and arrange for its disposal or repair.
- The correct settings for use with this modem in New Zealand are as follows:
 - ATB0 (CCITT operation)
 - AT&G2 (1800Hz guard tone)
 - AT&P1 (decadic dialing make-break ratio =33%/67%)
 - ATS0=0 (disable auto answer)
 - ATS6=4 (blind dial delay)
 - ATS7=Less than 90 (time to wait for carrier after dialing)
 - ATS10=Less than 150 (loss of carrier to hangup delay - the factory default of 15 is recommended)
 - ATS11=90 (DTMF dialing on/off duration in milliseconds)
 - ATX2 (dial tone detect, but not USA call progress detect)

-
- When used in Auto Answer mode, the S0 register must be set with to a value of either 3 or 4. This ensures:
 - a person calling your modem will hear a short burst of ringing before the modem answers. This confirms that the call has been successfully switched through the network.
 - caller identification information (which occurs between the first and second ring cadences) is not destroyed.
 - The preferred method of dialing is to use DTMF tones (ATDT..) as this is faster and more reliable than pulse (decadic) dialing. If for some reason you must use decadic dialing, your communications program must be set up to record numbers using the following translation table as this modem does not implement the New Zealand "Reverse Dialing" standard.

Number to be dialed: 0 1 2 3 4 5 6 7 8 9

Number to program into computer: 0 9 8 7 6 5 4 3 2 1

Note that where DTMF dialing is used, the numbers should be entered normally.

- The transmit level from this device is set at a fixed level and because of this there may be circumstances where the performance is less than optimal. Before reporting such occurrences as faults, please check the line with a standard Telepermitted telephone, and only report a fault if the phone performance is impaired.
- It is recommended that this equipment be disconnected from the Telecom line during electrical storms.
- When relocating the equipment, always disconnect the Telecom line connection before the power connection, and reconnect the power first.
- This equipment may not be compatible with Telecom Distinctive Alert cadences and services such as FaxAbility.

NOTE THAT FAULT CALLOUTS CAUSED BY ANY OF THE ABOVE CAUSES MAY INCUR A CHARGE FROM TELECOM

General conditions

As required by PTC 100, please ensure that this office is advised of any changes to the specifications of these products which might affect compliance with the relevant PTC Specifications.

The grant of this Telepermit is specific to the above products with the marketing description as stated on the Telepermit label artwork. The Telepermit may not be assigned to other parties or other products without Telecom approval.

A Telepermit artwork for each device is included from which you may prepare any number of Telepermit labels subject to the general instructions on format, size and color on the attached sheet.

The Telepermit label must be displayed on the product at all times as proof to purchasers and service personnel that the product is able to be legitimately connected to the Telecom network.

The Telepermit label may also be shown on the packaging of the product and in the sales literature, as required in PTC 100.

The charge for a Telepermit assessment is \$337.50. An additional charge of \$337.50 is payable where an assessment is based on reports against non-Telecom New Zealand Specifications. \$112.50 is charged for each variation when submitted at the same time as the original.

An invoice for \$NZ1237.50 will be sent under separate cover.

Following information is only for EU-member states:

Disposal of products



The crossed out wheeled dust bin symbol indicates that products must be collected and disposed of separately from household waste. Integrated batteries and accumulators can be disposed of with the product. They will be separated at the recycling centres.

The black bar indicates that the product was placed on the market after August 13, 2005.

By participating in separate collection of products and batteries, you will help to assure the proper disposal of products and batteries and thus help to prevent potential negative consequences for the environment and human health.

For more detailed information about the collection and recycling programmes available in your country, please visit our website (<http://eu.computers.toshiba-europe.com>) or contact your local city office or the shop where you purchased the product.

Disposal of batteries and/or accumulators



The crossed out wheeled dust bin symbol indicates that batteries and/or accumulators must be collected and disposed of separately from household waste.

If the battery or accumulator contains more than the specified values of lead (Pb), mercury (Hg), and/or cadmium (Cd) defined in the Battery Directive (2006/66/EC), then the chemical symbols for lead (Pb), mercury (Hg) and/or cadmium (Cd) will appear below the crossed out wheeled dust bin symbol.

By participating in separate collection of batteries, you will help to assure the proper disposal of products and batteries and thus help to prevent potential negative consequences for the environment and human health.

For more detailed information about the collection and recycling programmes available in your country, please visit our website (<http://eu.computers.toshiba-europe.com>) or contact your local city office or the shop where you purchased the product.



This symbol may not be displayed depending on the country and region where you purchased.

ENERGY STAR® Program



Your Computer model may be ENERGY STAR® compliant. If the model you purchased is compliant, it is labeled with the ENERGY STAR logo on the computer and the following information applies.

TOSHIBA is a partner in the ENERGY STAR Program and has designed this computer to meet the latest ENERGY STAR guidelines for energy efficiency. Your computer ships with the power management options preset to a configuration that will provide the most stable operating environment and optimum system performance for both AC power and battery modes.

To conserve energy, your computer is set to enter the low-power Sleep mode which shuts down the system and display within 15 minutes of inactivity in AC power mode. TOSHIBA recommends that you leave this and other energy saving features active, so that your computer will operate at its maximum energy efficiency. You can wake the computer from Sleep mode by pressing the power button.

Products that earn the ENERGY STAR prevent greenhouse gas emissions by meeting strict energy efficiency guidelines set by the US EPA and the EU Commission. According to the EPA, a computer meeting the new ENERGY STAR specifications will use between 20% and 50% less energy depending on how it is used.

Visit <http://www.eu-energystar.org> or <http://www.energystar.gov> for more information regarding the ENERGY STAR Program.

Optical disc drive standards

TOSHIBA Satellite A350/Satellite A350D series computer is shipped with one of the following drives preinstalled: DVD Super Multi (+-R DL) drive or DVD Super Multi (+-R DL) /w Label Flash drive.

The drive has one of the following labels:

CLASS 1 LASER PRODUCT
LASER KLASSE 1
LUOKAN 1 LASERLAITE
APPAREIL A LASER DE CLASSE1
KLASS 1 LASER APPARAT

Before it is shipped, the Class 1 Laser is certified to meet the United States Chapter 21 Standards of the Department of Health and Human Services (DHHS 21 CFR).

For any other country, the drive is certified to meet the Class 1 Laser standards of IEC825 and EN60825.

Optical disc drive safety instructions



- *The drive employs a laser system. To ensure proper use of this product, please read this instruction manual carefully and retain for future reference.
Should the unit ever require maintenance, contact an authorized service location.*
- *Use of controls, adjustments or the performance of procedures other than those specified may result in hazardous radiation exposure*
- *To prevent direct exposure to the laser beam, do not try to open the enclosure.*

DVD Super Multi (+-R DL) drive

Panasonic UJ880AD/UJ880ED

Location of the required label

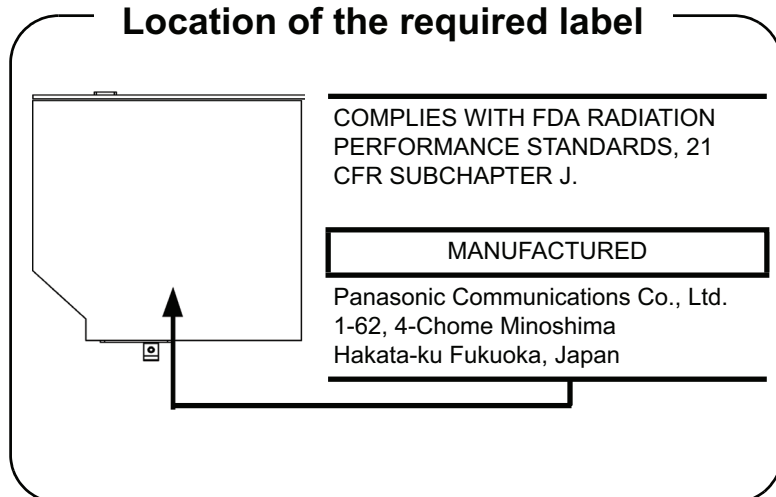

HLDS GSA-T50N/GSA-T50F

Location of the required label

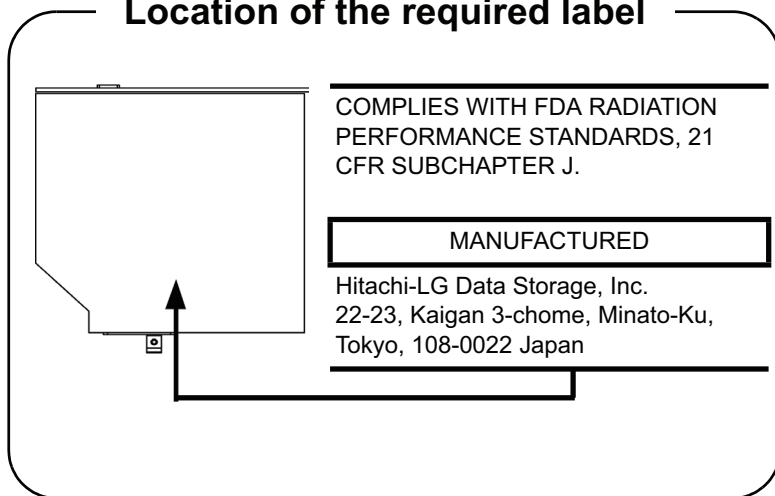

Pioneer DVR-TD08TBM/DVR-TD08TBF

Location of the required label

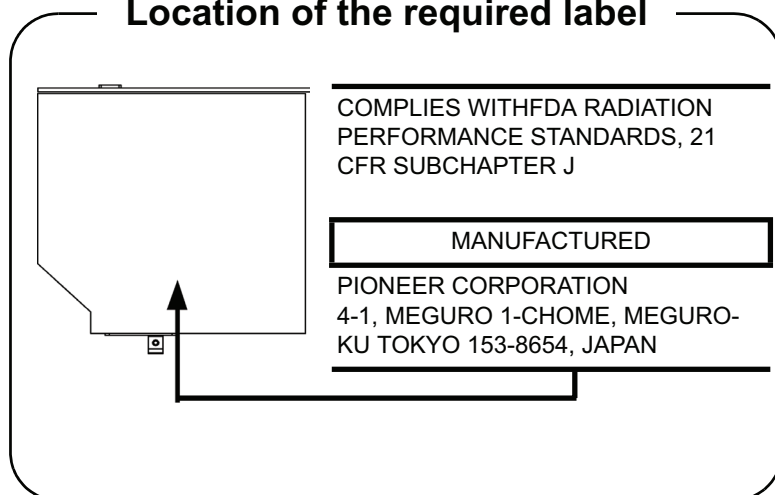

Location of the required label

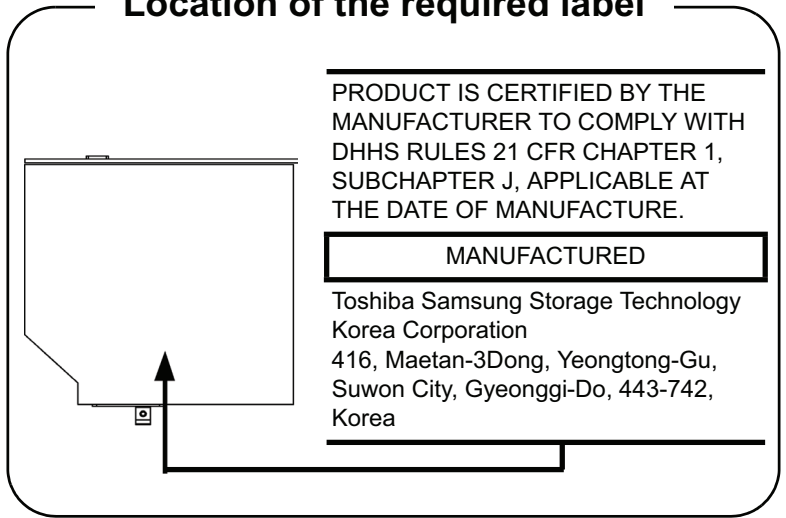

International precautions

CLASS 1 LASER PRODUCT
LASER KLASSE 1 PRODUKT
TO EN 60825-1
クラス1レーザー製品

CAUTION: *This appliance contains a laser system and is classified as a "CLASS 1 LASER PRODUCT." To use this model properly, read the instruction manual carefully and keep this manual for your future reference. In case of any trouble with this model, please contact your nearest "AUTHORIZED service station." To prevent direct exposure to the laser beam, do not try to open the enclosure.*

CLASS 1 LASER PRODUCT
LASERSCHUTZKLASSE 1
PRODUKT
TOEN60825

VORSICHT: *Dieses Gerät enthält ein Laser-System und ist als "LASERSCHUTZKLASSE 1 PRODUKT" klassifiziert. Für den richtigen Gebrauch dieses Modells lesen Sie bitte die Bedienungsanleitung sorgfältig durch und bewahren diese bitte als Referenz auf. Falls Probleme mit diesem Modell auftreten, benachrichtigen Sie bitte die nächste "autorisierte Service-Vertretung". Um einen direkten Kontakt mit dem Laserstrahl zu vermeiden darf das Gerät nicht geöffnet werden.*

ADVERSEL:USYNLIG
LASERSTRÅLING VED
ÅBNING, NÅR
SIKKERHEDSAF-BRYDER
ER UDE AF FUNKTION.
UNDGÅ UDSÆTTSELSE
FOR STRÅLING

ADVARSEL: *Denne mærking er anbragt udvendigt på apparatet og indikerer, at apparatet arbejder med laserstråler af klasse 1, hvilket betyder, at der anvendes laserstråler af svageste klasse, og at man ikke på apparatets yderside kan bilve udsat for utilladelig kraftig stråling.*

**APPARATET BOR KUN ÅBNES AF
FAGFOLK MED SÆRLIGT KENDSKAB
TIL APPARATER MED
LASERSTRÅLER!**

Indvendigt i apparatet er anbragt den her gengivne advarselsmærkning, som advarer imod at foretage sådanne indgreb i apparatet, at man kan komme til at udsatte sig for laserstråling.

OBS! Apparaten innehåller laserkomponent som avger laserstråling överstigande gränsen för laserklass 1.

VAROITUS. Suojakoteloä si saa avata. Laite sisältää laserdiodin, joka lähettää näkymätöntä silmilie vaarallista lasersäteilyä.

CAUTION: USE OF CONTROLS OR ADJUSTMENTS OR PERFORMANCE OF PROCEDURES OTHER THAN THOSE SPECIFIED IN THE OWNER'S MANUAL MAY RESULT IN HAZARDOUS RADIATION EXPOSURE.

VORSICHT: DIE VERWENDUNG VON ANDEREN STEURUNGEN ODER EINSTELLUNGEN ODER DAS DURCHFÜHREN VON ANDEREN VORGÄNGEN ALS IN DER BEDIENUNGSANLEITUNG BESCHRIEBEN KÖNNEN GEFÄHRLICHE STRAHLENEXPOSITIONEN ZUR FOLGE HABEN.

Important notice

Copyrighted works including, but not limited to music, video, computer program, databases are protected by copyright laws. Unless specifically permitted under applicable copyright laws, you cannot copy, modify, assign, transmit or otherwise dispose of any copyrighted work with the consent of the owner of the copyright. Please take notice that unauthorized copying, modification, assignment, transmission and disposition may be subject to claims for damages and penalties.

- Avoid using a telephone (other than a cordless type) during an electrical storm. There may be a remote risk of electric shock from lightning.
- Do not use the telephone to report a gas leak in the vicinity of the leak.
- Use only the power cord indicated in this manual.
- Replace only with the same or equivalent type battery recommended by the manufacturer.
- Dispose of used batteries according to the manufacturer's instructions.



Use only the battery pack that came with the computer or an optional battery pack. Use of wrong battery could damage your computer. TOSHIBA assumes no liability for any damage in such case.

Table of Contents

Copyright	ii
Disclaimer	ii
Trademarks	ii
Macrovision License of Notice	iii
Safety instructions	iii
FCC information	v
EU Declaration of Conformity	vi
VCCI Class B Information	vi
Canadian regulatory information (Canada only)	vi
Modem warning notice	vi
Japan regulations	vii
Instructions for IC CS-03 certified equipment	ix
Notes for Users in Australia and New Zealand	x
Following information is only for EU-member states:	xiii
Optical disc drive standards	xiv
International precautions	xviii
Important notice	xix
Preface	
Manual contents	xxiv
Conventions	xxv
General Precautions	
Creating a computer-friendly environment	xxvii
Stress injury	xxvii
Heat injury	xxviii
Pressure or impact damage	xxviii
ExpressCard overheating	xxviii
Mobile phones	xxviii
Instruction Manual for Safety and Comfort	xxviii
<i>Chapter 1</i> Introduction	
Equipment checklist	1-1
Features	1-3

	Special features	1-11
	TOSHIBA Value Added Package	1-13
	Utilities and Applications	1-14
	Options	1-17
<i>Chapter 2</i>	The Grand Tour	
	Front with the display closed	2-1
	Left side	2-3
	Right side	2-5
	Back side	2-7
	Underside	2-7
	Front with the display open	2-8
	Function button	2-11
	System indicators	2-12
	Optical disc drives	2-14
	Remote Controller	2-15
	Using the Remote Controller	2-18
	Installing/Removing batteries	2-19
	AC adaptor	2-22
<i>Chapter 3</i>	Getting Started	
	Connecting the AC adaptor	3-2
	Opening the display	3-5
	Turning on the power	3-6
	Starting up for the first time	3-7
	Turning off the power	3-7
	Restarting the computer	3-11
	System Recovery Options	3-11
<i>Chapter 4</i>	Operating Basics	
	Using the Touch Pad	4-1
	Using the Fingerprint Sensor	4-2
	USB Sleep and Charge function	4-9
	Using optical disk drives	4-10
	Function button	4-14
	Writing CD/DVD on DVD Super Multi drives	4-15
	Media care	4-26
	Sound system	4-27
	Using the web camera	4-29
	Using TOSHIBA Face Recognition	4-31
	Modem	4-34
	Wireless communications	4-38
	LAN	4-41
	Cleaning the computer	4-43
	Moving the computer	4-44
	Heat dispersal	4-44

<i>Chapter 5</i>	The Keyboard	
	Typewriter keys	5-1
	Function keys: F1 ... F12	5-2
	Soft keys: FN key combinations	5-2
	Hot keys	5-3
	Windows special keys	5-5
	Keypad overlay	5-6
	Generating ASCII characters	5-7
<i>Chapter 6</i>	Power and Power-up Modes	
	Power conditions	6-1
	Power indicators	6-2
	Battery types	6-3
	Care and use of the battery pack	6-5
	Replacing the battery pack	6-9
	TOSHIBA Password Utility	6-12
	Power-up modes	6-13
<i>Chapter 7</i>	HW Setup and Passwords	
	HW Setup	7-1
	Accessing HW Setup	7-1
	HW Setup Window	7-1
<i>Chapter 8</i>	Optional Devices	
	ExpressCard	8-2
	Bridge media slot	8-3
	Additional memory module	8-5
	Battery Packs	8-9
	Universal AC Adaptor	8-9
	Battery Charger	8-9
	USB floppy diskette drive	8-9
	eSATA (External Serial ATA)	8-11
	External monitor	8-13
	HDMI	8-13
	Television	8-16
	i.LINK (IEEE1394)	8-17
	Security lock	8-19
<i>Chapter 9</i>	Troubleshooting	
	Problem solving process	9-1
	Hardware and system checklist	9-3
	TOSHIBA support	9-25
<i>Chapter 10</i>	Disclaimers	
	CPU	10-1
	Memory (Main System)	10-2
	Battery Life	10-3

	HDD drive capacity	10-3
	LCD	10-3
	Graphics Processor Unit ("GPU")	10-3
	Wireless LAN	10-3
	USB Sleep & Charge	10-4
	External HDD Capacity	10-4
	Non-applicable Icons	10-4
	Copy Protection	10-4
	Images	10-4
	LCD Brightness and Eye Stain	10-4
<i>Appendix A</i>	Specifications	
	Environmental requirements	A-1
<i>Appendix B</i>	Display Controller	
	Display controller	B-1
<i>Appendix C</i>	V.90/V.92	
	V.90/V.92 mode	C-1
	AT Command	C-3
<i>Appendix D</i>	Wireless LAN	
	Card Specifications	D-1
	Radio Characteristics	D-2
	Supported Frequency Sub-bands	D-2
<i>Appendix E</i>	AC Power Cord and Connectors	
	Certification agencies	E-2
	Glossary	
	Index	

Glossary

Preface

Congratulations on your purchase of the TOSHIBA Satellite A350/Satellite A350D series computer. This powerful notebook computer provides excellent expansion capability, includes multimedia functionality, and is designed to provide years of reliable, high-performance computing.

This manual tells how to set up and begin using your TOSHIBA Satellite A350/Satellite A350D series computer. It also provides detailed information on configuring your computer, basic operations and care, using optional devices and troubleshooting.

If you are a new user of computers or if you're new to portable computing, first read over the *Introduction* and *The Grand Tour* chapters to familiarize yourself with the computer's features, components and accessory devices. Then read *Getting Started* for step-by-step instructions on setting up your computer.

If you are an experienced computer user, please continue reading the preface to learn how this manual is organized, then become acquainted with this manual by browsing through its pages. Be sure to read the *Special features* section of the Introduction, to learn about features that are uncommon or unique to the computers and carefully read *HW Setup and Passwords*. If you are going to install ExpressCards or connect external devices such as a printer, be sure to read Chapter 8, *Optional Devices*.

Manual contents

This manual is composed of the following chapters, appendixes, a glossary and an index.

Chapter 1, *Introduction*, is an overview of the computer's features, capabilities, and options.

Chapter 2, *The Grand Tour*, identifies the components of the computer and briefly explains how they function.

Chapter 3, *Getting Started*, provides a quick overview of how to begin operating your computer.

Chapter 4, *Operating Basics*, includes tips on care of the computer and on using the touchpad, the fingerprint sensor, optical disc drive, Audio/Video controls, the web camera, the microphone, the internal modem, the FM tuner, wireless communication and LAN.

Chapter 5, *The Keyboard*, describes special keyboard functions including the keypad overlay and hot keys.

Chapter 6, *Power and Power-up Modes*, gives details on the computer's power resources and battery save modes.

Chapter 7, *HW Setup and Passwords*, explains how to configure the computer using the HW Setup program. It also tells how to set a password.

Chapter 8, *Optional Devices*, describes the optional hardware available.

Chapter 9, *Troubleshooting*, provides helpful information on how to perform some diagnostic tests, and suggests courses of action if the computer doesn't seem to be working properly.

Chapter 10 *Disclaimers*, provides Legal Footnotes information related to your computer.

The *Appendixes* provide technical information about your computer.

The *Glossary* defines general computer terminology and includes a list of acronyms used in the text.

The *Index* quickly directs you to the information contained in this manual.

Conventions

This manual uses the following formats to describe, identify, and highlight terms and operating procedures.

Abbreviations

On first appearance, and whenever necessary for clarity, abbreviations are enclosed in parentheses following their definition. For example: Read Only Memory (ROM). Acronyms are also defined in the Glossary.

Icons

Icons identify ports, dials, and other parts of your computer. The indicator panel also uses icons to identify the components it is providing information on.

Keys

The keyboard keys are used in the text to describe many computer operations. A distinctive typeface identifies the key top symbols as they appear on the keyboard. For example, **ENTER** identifies the **ENTER** key.

Key operation

Some operations require you to simultaneously use two or more keys. We identify such operations by the key top symbols separated by a plus sign (+). For example, **CTRL + C** means you must hold down **CTRL** and at the same time press **C**. If three keys are used, hold down the first two and at the same time press the third.

ABC When procedures require an action such as clicking an icon or entering text, the icon's name or the text you are to type in is represented in the typeface you see to the left.

Display

ABC Names of windows or icons or text generated by the computer that appear on its display screen are presented in the type face you see to the left.

Messages

Messages are used in this manual to bring important information to your attention. Each type of message is identified as shown below.



Pay attention! A caution informs you that improper use of equipment or failure to follow instructions may cause data loss or damage your equipment.



Please read. A note is a hint or advice that helps you make best use of your equipment.



Indicates a potentially hazardous situation, which could result in death or serious injury, if you do not follow instructions.

Terminology

This term is defined in this document as follows:

Start The word "**Start**" refers to the "" button in Microsoft® Windows Vista®.

General Precautions

TOSHIBA computers are designed to optimize safety, minimize strain and withstand the rigors of portability. However, certain precautions should be observed to further reduce the risk of personal injury or damage to the computer.

Be certain to read the general precautions below and to note the cautions included in the text of the manual.

Creating a computer-friendly environment

Place the computer on a flat surface that is large enough for the computer and any other items you are using, such as a printer.

Leave enough space around the computer and other equipment to provide adequate ventilation. Otherwise, they may overheat.

To keep your computer in prime operating condition, protect your work area from:

- Dust, moisture, and direct sunlight.
- Equipment that generates a strong electromagnetic field, such as stereo speakers (other than speakers that are connected to the computer) or speakerphones.
- Rapid changes in temperature or humidity and sources of temperature change such as air conditioner vents or heaters.
- Extreme heat, cold, or humidity.
- Liquids and corrosive chemicals.

Stress injury

Carefully read the *Instruction Manual for Safety and Comfort*. It contains information on the prevention of stress injuries to your hands and wrists that can be caused by extensive keyboard use.

Heat injury

- Avoid prolonged physical contact with the computer. If the computer is used for long periods, its surface can become very warm. While the temperature will not feel hot to the touch, if you maintain physical contact with the computer for a long time, for example if you rest the computer on your lap or if you keep your hands on the palm rest, your skin might suffer a low-heat injury.
- If the computer has been used for a long time, avoid direct contact with the metal plate supporting the various interface ports as this can become hot.
- The surface of the AC adaptor can become hot when in use but this condition does not indicate a malfunction. If you need to transport the AC adaptor, you should disconnect it and let it cool before moving it.
- Do not lay the AC adaptor on a material that is sensitive to heat as the material could become damaged.

Pressure or impact damage

Do not apply heavy pressure to the computer or subject it to any form of strong impact as this can damage the computer's components or otherwise cause it to malfunction.

ExpressCard overheating

Some ExpressCards can become hot during prolonged use which may result in errors or instability in the operation of the device in question. In addition, you should also be careful when you remove an ExpressCard that has been used for a long time.

Mobile phones

Please be aware that the use of mobile phones can interfere with the audio system. The operation of the computer will not be impaired in any way, but it is recommended that a minimum distance of 30cm is maintained between the computer and a mobile phone that is in use.

Instruction Manual for Safety and Comfort

All important information on the safe and proper use of this computer is described in the enclosed Instruction Manual for Safety and Comfort. Be sure to read it before using the computer.

Chapter 1

Introduction

This chapter provides an equipment checklist, and it identifies the computer's features, options and accessories.



Some of the features described in this manual may not function properly if you use an operating system that was not pre-installed by TOSHIBA.

Equipment checklist

Carefully unpack your computer, taking care to save the box and packaging materials for future use.

Hardware

Check to make sure you have all the following items:

- TOSHIBA Satellite A350/Satellite A350D series Portable Personal Computer
- AC adaptor and power cord (2-pin plug or 3-pin plug)
- Battery pack (is pre-installed in some computer)
- Remote controller (is included with some models)
- Two AA manganese batteries
- CR2016 battery (for Slim size remote controller)
- Cleaning cloth (is included with some models)
- FM tuner antenna (is included with some models)



- *Some models are included with Slim size remote controller.*
- *Use the cleaning cloth to wipe away dust, fingerprints and similar from the keyboard, palm rest and other parts. For precautions on use refer to the Using the cleaning cloth section in Chapter 4, [Operating Basics](#).*

Software

The following Windows® operating system and utility software are pre-installed.

- Microsoft® Windows Vista®
- Modem Driver (Can be used only for Modem models)
- Bluetooth Driver (Can be used only for Bluetooth models)
- Display Drivers for Windows
- TOSHIBA Value Added Package
- TOSHIBA Hardware Setup
- TOSHIBA Supervisor Password
- Ulead DVD MovieFactory®
- Fingerprint Utility (Can be used only for Fingerprint Utility models)
- LAN Driver
- Pointing Device Driver
- Sound Driver for Windows
- Wireless LAN Driver (Can be used only for Wireless LAN models)
- Windows Mobility Center
- TOSHIBA Face Recognition (is pre-installed in some models)
- TOSHIBA Disc Creator
- TOSHIBA Recovery Disc Creator
- TOSHIBA ConfigFree™
- TOSHIBA SD Memory Utilities
- TOSHIBA Assist
- TOSHIBA CD/DVD Drive Acoustic Silencer
- TOSHIBA DVD PLAYER
- Online Manual
 - TOSHIBA Satellite A350/Satellite A350D series User's Manual (This manual)



*SD Memory Card Format Utility and other SD functions are packaged into TOSHIBA SD Memory Utilities. When uninstalling the SD utilities, click **Start** -> **Control Panel** -> **Uninstall a program**, and select TOSHIBA SD Memory Utilities.*

Documentation

- TOSHIBA Satellite A350/Satellite A350D series Portable Personal Computer User's Manual (User's Manual)
- Instruction Manual for Safety and Comfort
- End User License Agreement

If any of the items are missing or damaged, contact your dealer immediately.

Features

This computer incorporates the following features and benefits:

Processor

Built-in	Your computer is equipped with one processor and processor type varies depending on model. To check which type of processor is included in your model, open the TOSHIBA PC Diagnostic Tool Utility by clicking Start -> All programs -> TOSHIBA -> Utilities -> TOSHIBA PC diagnostic Tool .
-----------------	---

Chipset

Mobile Intel® PM45 Express Chipset

Mobile Intel® GM45 Express Chipset

Mobile Intel® GL40 Express Chipset

or

AMD M780V chipset

AMD M780G chipset

AMD M770 chipset

Memory

Slots	<p>PC2-6400 1 GB, 2 GB or 4 GB memory modules can be installed in the two memory slots of below models:</p> <p>Mobile Intel® GM45 Express Chipset model/ Mobile Intel® PM45 Express Chipset model/ Mobile Intel® GL40 Express Chipset model/ AMD M780V Chipset model/ AMD M780G Chipset model/ AMD M770 Chipset model.</p> <p>Maximum system memory size and speed are depending on the model you purchased.</p>
--------------	---



- *Maximum size of memory can be installed on Mobile Intel® GL40 Express Chipset models is 4GB.*
- *PC2-6400 memory module works as PC2-5300 speed on Mobile Intel® GL40 Express Chipset models.*
- *PC2-6400 memory module works as PC2-5300 speed on AMD Athlon™ 64x2 Dual-Core Processor.*

Video RAM

Video RAM Depending on the model you purchased.

Mobile Intel® GM45 Express Chipset model/
Mobile Intel® GL40 Express Chipset model:
Video RAM capacity shares with main memory, and the proportion depends on Dynamic Video Memory Technology.

Mobile Intel® GM45 Express Chipset model/
Mobile Intel® PM45 Express Chipset model in graphic chip by ATI Mobility Radeon™ HD 3470:
External 128/256MB

Mobile Intel® GM45 Express Chipset model/
Mobile Intel® PM45 Express Chipset model in graphic chip by ATI Mobility Radeon™ HD 3650:
External 256/512MB

AMD M780G Chipset model/ AMD M780V Chipset model:
Video RAM capacity shares with main memory, and the proportion depends on ATI HyperMemory™.

AMD M780G Chipset model/ AMD M770 Chipset model in graphic chip by ATI Mobility Radeon™ HD 3470: External 128/256MB

AMD M770 Chipset model in graphic chip by ATI Mobility Radeon™ HD 3650: External 256/512MB

Disks

Hard disk drive or Solid state drive

This computer is equipped with the following types of hard disk drive(HDD). The capacity of each hard disk drive model is different.

- HDD
 - 120GB
 - 160GB
 - 250GB
 - 320GB
 - 400GB
 - 500GB



Please note that part of the hard disk drives overall capacity is reserved as administration space.



Additional hard disk drive sizes may be introduced.

Keyboard

Built-in

The internal keyboard provides the embedded numeric overlay keys, dedicated cursor control overlay keys,  and  Keys. The keyboard is compatible with the IBM® enhanced keyboard. Refer to Chapter 5, [The Keyboard](#), for details.

Pointing Device

Built-in Touch Pad

The integrated Touch Pad and control buttons in the palm rest allow control of the on-screen pointer and support functions such as the scrolling of windows.

Power

Battery pack

The computer is powered by one rechargeable lithium-ion battery pack.

RTC battery

The internal RTC battery backs up the Real Time Clock (RTC) and calendar.

AC adaptor	<p>The AC adaptor provides power to the system and recharges the batteries when they are low. It comes with a detachable power cord which will either have a 2-pin or 3-pin plug enclosure.</p> <p>As the AC adaptor is universal, it can receive a range of AC voltages from 100 to 240 volts, however you should note that the output current varies among different models. Using the wrong adaptor can damage your computer. Refer to the AC adaptor section in Chapter 2, <i>The Grand Tour</i>.</p>
-------------------	---

Ports

External monitor	<p>This port provides 15-pin, analog VGA port. This port allows you to connect an external monitor to the computer.</p>
Universal Serial Bus (USB 2.0)	<p>The computer supports multiple Universal Serial Bus ports that comply with the USB 2.0 standard. The ports with the () has a USB Sleep and Charge function.</p> <p>One of the USB ports has an eSATA (External Serial ATA) function.</p>
i.LINK™ (IEEE1394)	<p>This port allows high-speed data transfer to take place between the computer and external devices such as digital video cameras.</p>

Slots

ExpressCard™	<p>The internal ExpressCard slot is a Universal slot. This slot supports ExpressCard/54 and ExpressCard/34 modules.</p>
Bridge media	<p>This slot lets you insert an SD™/SDHC™ memory card, miniSD™/microSD™ Card, Memory Stick® (PRO™/PRO Duo™), xD-Picture Card™ and MultiMediaCard™. Refer to Chapter 8, Optional Devices.</p>

Multimedia

Sound system	The integrated sound system provides support for the computer's internal speakers and microphone, also allowing an external microphone and headphones to be connected via the appropriate jacks.
Web Camera	Web Camera is a device that allows you to record video or take photographs with your computer. You can use it for video chatting or video conferences using a communication tool such as Windows Live Messenger . Camera Assistant Software will help you to add various video effects to your video or photograph.
HDMI out port	HDMI out port can connect with Type A connector HDMI cable. HDMI cable can send video and audio signals. In addition to this, it can send and receive control signals. By connecting a TV which supports HDMI Control to this port, the remote control for the connected TV can be used to operate some of the computer functions. Refer to the REGZA Link (PC Control) section in Chapter 8, Optional Devices, for more details.
Headphone (S/PDIF) jack	This jack lets you connect digital speakers or a stereo headphone (16 ohm minimum). When you connect a digital speaker or headphones, the internal speaker is automatically disabled. This jack can be used also as S/PDIF jack and enables connection of optical digital correspondence apparatus.
Microphone jack	A 3.5mm mini microphone jack enables connection of a three-conductor mini jack for stereo microphone input, and connection of a stereo device for audio input.
FM Tuner	Connecting the included FM Tuner antenna to this jack enables reception of FM broadcasts. Some models are equipped with the FM tuner jack.

Infrared receiver window	<p>This is a sensor window that receives signals from the remote controller which is provided with your computer.</p> <p>Models which do not include a remote controller are not equipped with an infrared receiver so the computer cannot be operated with a remote controller.</p>
Slim size remote controller	<p>Use this device to navigate when playing CDs/DVDs. This device is stored within the ExpressCard slot (Provided with some models).</p>

Communications

Modem	<p>Some models are equipped with the integrated modem. The integrated modem provides capability for data and fax communications that support the V.90 (V.92) standards and includes a modem jack for connection to the telephone line. Please note that both the V.90 and V.92 standards are only supported in the USA and Canada. Only the V.90 standard is supported in other regions. You should also be aware that the speed of data and fax transfer will depend on the analog telephone line conditions. The integrated model is only installed as a standard device in some markets.</p>
LAN	<p>The computer has built-in support for Ethernet LAN (10 megabits per second, 10BASE-T), Fast Ethernet LAN (100 megabits per second, 100BASE-TX) and Gigabit Ethernet LAN (1000 megabits per second, 1000BASE-T).</p> <p>It is pre-installed as a standard device in some markets.</p>
Bluetooth™	<p>Some computers in this series have Bluetooth wireless communication function which eliminates the need for cables between electronic devices such as computers and printers and mobile phones. When it is enabled, Bluetooth provides the wireless personal area network environment which is safe and trustworthy, that is quick and easy.</p>
Wireless LAN	<p>Some computers in this series are equipped with a Wireless LAN module that is compatible with other LAN systems based on Direct Sequence Spread Spectrum/Orthogonal Frequency Division Multiplexing radio technology that complies with the IEEE 802.11 Standard.</p>



- *The transmission speed over the wireless LAN and the distance over which wireless LAN can reach may vary depending on surrounding electromagnetic environment, obstacles, access point design and configuration, and client design and software/hardware configurations. The Transmit Rate (at X Mbit/s) is the theoretical maximum speed under the IEEE802.11 (a/b/g/n) standards. The actual transmission speed will be lower than the theoretical maximum speed.*

Wireless communication switch

This switch turns the Wireless LAN, and Bluetooth functions on and off.

Security

Security lock slot

Connects a security lock to anchor the computer to a desk or other large object.

Optical disc drive

DVD Super Multi drive

The drive reads DVD-ROM's at a maximum 8x speed and CD-ROM's at a maximum 24x speed, and writes CD-R's at up to 24x speed, CD-RW's at up to 24x speed, DVD-R's and DVD+R's at up to 8x speed, DVD-RW's and DVD+RW's at up to 8x speed, DVD-R (Dual layer) at up to 6x speed, DVD+R (Double Layer) at up to 6x speed and DVD-RAM at up to 5x speed, and supports the following formats:

- CD-R
- CD-RW
- DVD-ROM
- DVD-Video
- CD-DA
- CD-Text
- Photo CD™ (single/multi-session)
- CD-ROM Mode 1, Mode 2
- CD-ROM XA Mode 2 (Form1, Form2)
- Enhanced CD (CD-EXTRA)
- Addressing Method 2
- DVD-R
- DVD-R (Dual Layer)
- DVD-RW
- DVD+R
- DVD+R (Double Layer)
- DVD+RW
- DVD-RAM

Some models are equipped with a full-size DVD Super Multi drive module that lets you run CD's or DVD's without using an adaptor.

DVD Super Multi drive with Labelflash

The drive reads DVD-ROM's at a maximum 8x speed and CD-ROM's at a maximum 24x speed, and writes CD-R's at up to 24X speed and CD-RW's at up to 24X speed. DVD-R's, DVD+R's and DVD+RW's at up to 8x speed, DVD-RW's at up to 8X speed, DVD-R (Dual Layer) and DVD+R (Double Layer) at up to 6x speed, DVD-RAM at up to 5x speed. This drive supports the same formats as the DVD Super Multi drive.

Software

The computer's internal display panel supports high-resolution video graphics and can be set to a wide range of viewing angles for maximum comfort and readability.

Operating system	Microsoft® Windows Vista® is available. Refer to the preinstalled Software section at the front of this chapter.
TOSHIBA Utilities	A number of utilities and drivers are preinstalled to make your computer more convenient to use. Refer to the Utilities and applications section in this chapter.
Plug and Play	When you connect an external device to the computer or when you install a component, Plug and Play capability enables the system to recognize the connection and make the necessary configurations automatically.

Special features

The following features are either unique to TOSHIBA computers or are advanced features which make the computer more convenient to use.

Access each function using the following procedures.

*1 To access the Power Options, click **Start** -> **Control Panel** -> **System and Maintenance** -> **Power Options**.

Hot keys	Hot keys are specific key combinations that let you quickly change the system configuration directly from the keyboard without running a system program.
Display automatic power off *1	This feature automatically cuts off power to the computer's display panel when there is no keyboard input for a specified time, with power being restored the next time a key is pressed. This can be specified in the Power Options.
HDD automatic power off *1	This feature automatically cuts off power to the hard disk drive when it is not accessed for a specified time, with power being restored when the hard disk drive is next accessed. This can be specified in the Power Options.
System automatic Sleep/Hibernation Mode *1	This feature automatically shuts down the system into either Sleep Mode or Hibernation Mode when there is no input or hardware access for a specified time. This can be specified in the Power Options.

Keypad overlay	A ten-key numeric keypad is integrated into the keyboard. Please refer to the Keypad overlay section in Chapter 5, The Keyboard , for information on using this feature.
Power on password	Two levels of password security, supervisor and user, are available to prevent unauthorized access to your computer.
Instant security	A specific hot key function automatically locks the system providing data security.
Intelligent power supply *1	A microprocessor in the computer's intelligent power supply detects the battery's charge, automatically calculates the remaining battery capacity and protects electronic components from abnormal conditions such as a voltage overload from the AC adaptor. This can be specified in the Power Options.
Battery save mode *1	This feature lets you configure the computer in order to save battery power. This can be specified in the Power Options.
Low battery automatic Hibernation Mode *1	When battery power is exhausted to the point that computer operation cannot be continued, the system automatically enters Hibernation Mode and shuts itself down. This can be specified in the Power Options.
Heat dispersal *1	To protect against overheating, the processor has an internal temperature sensor so that, if the computer's internal temperature rises to a certain level, the cooling fan is turned on or the processing speed is lowered. This can be specified in the Power Options.



If the processor's temperature reaches an unacceptably high level with either setting, the computer will automatically shut down to prevent any damage - in this instance all unsaved data in memory will be lost.

Hibernation Mode	This feature lets you turn off the power to the computer without exiting from your software. The contents of main memory are automatically saved to the hard disk drive so that when you next turn the power on again, you can continue working right where you left off. Refer to the Turning off the power section in Chapter 3, Getting Started , for more details.
-------------------------	--

Sleep Mode	If you have to interrupt your work, you can use this feature to allow you to turn off power to the computer without exiting from your software. Data is maintained in the computer's main memory so that when you next turn on the power, you can continue working right where you left off.
-------------------	--

TOSHIBA Value Added Package

This section describes the TOSHIBA Component features pre-installed on the computer.

TOSHIBA Power Saver	TOSHIBA Power Saver provides you with the features of more various power supply managements.
TOSHIBA Button Support	<p>This utility controls the following computer button functions.</p> <ul style="list-style-type: none"> ■ Mute button ■ CD/DVD button <p>The starting application from the button can be changed.</p>
TOSHIBA Zooming Utility	This utility allows you to enlarge or reduce the icon size on the Windows Desktop, or the zoom factor associated with specific supported applications.
TOSHIBA PC Diagnostic Tool	The TOSHIBA PC Diagnostic Tool will display basic system configuration information and allow the functionality of some of the computer's built-in hardware devices to be tested.
TOSHIBA Flash Cards	<p>The TOSHIBA Flash Cards provide a quick way to modify selected system functions and to launch applications.</p> <ul style="list-style-type: none"> ■ Hot key function ■ TOSHIBA utility launcher function
TOSHIBA Accessibility	The TOSHIBA Accessibility utility provides support to movement impaired users when they need to use the TOSHIBA Hot-key functions. In use, the utility allows you to make the FN key 'sticky', that is you can press it once, release it, and they press one of the ' F ' keys in order to access its specific function. When set, the FN key will remain active until another key is pressed.

Utilities and Applications

This section describes the pre-installed utilities that come with the computer and details how to start them. For further information on their operation, please refer to each utility's online manual, help files or README.TXT file.

Fingerprint Utility

Some models of this computer series support a fingerprint utility, which is installed for the purpose of enrolling and recognizing fingerprints which can then be linked to a username and password in order to remove the need to input these details from the keyboard. Just by swiping an enrolled finger against the fingerprint sensor, the following functions will be enabled:

- Logon to Windows and access a security enabled homepage through Internet Explorer.
- Files and folders can be encrypted/decrypted and third party access to them is prevented.
- Disable the password-protected screen-saver when returning from a power-saving mode such as Sleep Mode.
- Authentication of the User Password (and, if applicable, the HDD(Hard Disk Drive) Password) when booting up the computer (Pre-OS Authentication).
- Single-Swipe Sign-on feature



- *Fingerprint security cannot be used in models that do not have a fingerprint module installed.*

TOSHIBA Face Recognition

TOSHIBA Face Recognition uses a face verification library to verify the face data of users when they log in to Windows. If the verification is successful, the user will be logged into Windows automatically. The user can thus avoid having to enter a password or the like, which makes the login process easier.

Bluetooth Stack for Windows by Toshiba

This software enables communication between the computer and external Bluetooth devices such as printers and mobile phones.



- Bluetooth functions cannot be used in models that do not have a Bluetooth module installed.*

TOSHIBA Assist	TOSHIBA Assist is a graphical user interface that provides access to specific tools, utilities and applications that make the use and configuration of the computer easier.
HW Setup utility	To start the utility, click the Windows Start button, point to All Programs , click TOSHIBA , click Utilities , and select HWSetup icon.
TOSHIBA ConfigFree	TOSHIBA ConfigFree is a suite of utilities that improve the ease and control of communication devices and network connections, help in the identification of communication problems and allow the creation of profiles if you need to switch between different locations and communication networks. To access this utility, click Start -> All Programs -> TOSHIBA -> ConfigFree .
TOSHIBA Disc Creator	<p>You can create CD's and DVD's in a number of formats including audio CD's that can be played on a standard CD player, and data CD's/DVD's which can store copies of the files and folders on your computer's hard disk drive. This software can be used on models with a DVD Super Multi drive.</p> <p>To start this utility, click Start -> All Programs -> TOSHIBA -> CD&DVD Applications -> Disc Creator.</p>
TOSHIBA DVD-RAM Utility	This utility has the function of Physical Format and Write-Protect to DVD-RAM. This utility is contained the setup module of TOSHIBA Disc Creator. To start this utility, click Start -> All Programs -> TOSHIBA -> CD&DVD Applications -> DVD-RAM Utility .
Ulead DVD MovieFactory for TOSHIBA	<p>Ulead DVD MovieFactory for TOSHIBA allows users to instantly create DVD video or slideshow discs via a user-friendly wizard interface with specific task oriented features.</p> <p>The Labelflash feature is also supported which allows text and images to be printed on the label surface of Labelflash compatible media without using a printer. Some models supports the Labelflash function.</p>



Labelflash features cannot be used in models that do not have a DVD Super Multi drive with Labelflash.

In order to determine if the optical disc drive installed in your computer supports Labelflash follow the steps as detailed below:

1. Click **Start** -> **All Programs** -> **DVD MovieFactory for TOSHIBA** -> **Ulead DVD MovieFactory for TOSHIBA Launcher** to launch DVD MovieFactory.
2. Click **Print Disc Label** -> **Label Printing. Ulead Label@Once** is started.
3. Click the **General** tab.
4. Choose optical disc drive for **Printer**.

If the drive name is displayed in Step 4, your computer's optical disc drive supports Labelflash.

Windows Mobility Center

This section describes the Windows Mobility Center. Mobility Center is a utility for accessing several mobile PC settings quickly in one window. A default maximum of eight tiles are provided by the operating system, and the additional two tiles are added to your Mobility Center.

■ Lock Computer:

This can be used to lock your computer without turning it off. This has the same function as the **Lock** button at the bottom of the right pane in the start menu.

■ TOSHIBA Assist:

This can be used to open **TOSHIBA Assist** if it is already installed in your computer.

TOSHIBA DVD PLAYER

This software is provided for playback of DVD Video. It has an on-screen interface and functions. Click **Start** -> **All Programs** -> **TOSHIBA DVD PLAYER**.



Frame dropping, audio skipping or out of synch audio and video may occur during playback of some DVD Video titles. Make sure to connect the computer's AC adaptor when playing a DVD Video. Power-saving features may interfere with smooth playback.

CD/DVD Drive Acoustic Silencer	The CD/DVD Drive Acoustic Silencer utility allows you to configure the read speed at which the optical disc drive will operate. In use you can select either Normal Mode , which will operate the drive at its maximum speed for quick data access, or Quiet Mode , which operates the drive at single speed for audio CD playback and which can lessen the operational noise. This utility does not have any function when using DVD's.
---------------------------------------	--

Options

You can add a number of options to make your computer even more powerful and convenient to use. The following options are available:

Memory expansion	1,024MB or 2,048MB memory module (DDR2-800) can easily be installed in the computer.
Battery Pack	An additional battery pack can be purchased for use as either a spare or replacement. Please refer to Chapter 6, <i>Power and Power-up Modes</i> for further information.
AC Adaptor	If you frequently use your computer at more than one site, it may be convenient to purchase an additional AC adaptor to be kept at each site in order to remove the need to always carry the adaptor with you.
USB FDD	The USB floppy diskette drive accommodates either a 1.44MB or 720KB floppy diskette through connection to one of the computer's USB ports. In use, please be aware that, while you cannot format 720KB floppy diskettes under Windows Vista®, you are able to read and write to diskettes that have already been formatted.
Security lock	A slot is available to attach a security cable to the computer to deter theft.

Chapter 2

The Grand Tour

This chapter identifies the various components of your computer. Become familiar with each component before you operate the computer.

Front with the display closed

The following figure shows the computer's front with its display panel in the closed position.

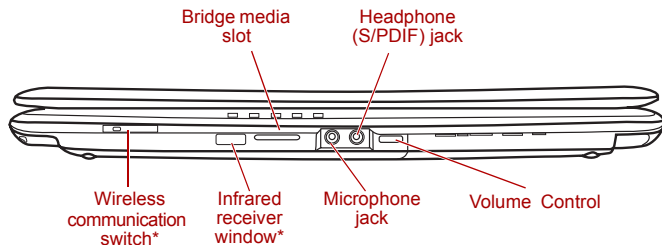

* Depending on the model you purchased.

Figure 2-1 Front of the computer with display closed

Off		On	<p>Wireless communication switch</p> <p>Slide this switch to the right to turn on Wireless LAN and Bluetooth functions. Slide it to the left to turn off the functions.</p>
-----	---	----	--



- *Turn Wi-Fi® and Bluetooth functionalities off when near a person who may have a cardiac pacemaker implant or other medical electric device. Radio waves may affect pacemaker or medical device operation, possibly resulting in serious injury. Follow the instruction of your medical device when using any Wi-Fi or Bluetooth functionality.*
- *Always turn off Wi-Fi® and Bluetooth functionality if the computer is near automatic control equipment or appliances such as automatic doors or fire detectors. Radio waves can cause malfunction of such equipment, possibly resulting in serious injury.*
- *Do not use the Wi-Fi® and Bluetooth functionalities near a microwave oven or in areas subject to radio interference or magnetic fields. Interference from a microwave oven or other source can disrupt Wi-Fi or Bluetooth operation.*

Infrared receiver window

This is a sensor window that receives signals from the remote control which is provided with your computer.



Models which do not include a remote controller are not equipped with an infrared receiver so the computer cannot be operated with a remote controller.



Bridge media slot

This slot lets you insert an SD™/SDHC™ memory card, miniSD™/microSD™ Card, Memory Stick® (PRO™/PRO Duo™), xD-Picture Card™ and MultiMediaCard™. Refer to Chapter 8, [Optional Devices](#).



Keep foreign metal objects, such as screws, staples and paper clips, out of the Bridge media slot. Foreign metal objects can create a short circuit, which can cause damage and fire, possibly resulting in serious injury.



Microphone jack

A 3.5 mm mini microphone jack enables connection of a three-conductor mini jack for monaural microphone input, and connection of a stereo device for audio input.



Headphone (S/PDIF) jack

A 3.5 mm mini headphone jack that lets you connect digital speakers or a stereo headphone (16 ohm minimum). When you connect a digital speaker or headphones, the internal speaker is automatically disabled.

This jack can be used also as S/PDIF jack and enables connection of optical digital correspondence apparatus.



Volume control

Use this dial to adjust the volume of the internal stereo speakers and optional external stereo headphones (if connected).

Move the Volume control to the right to decrease the volume and to the left to increase the volume.

Left side

The following figure shows the computer's left side.

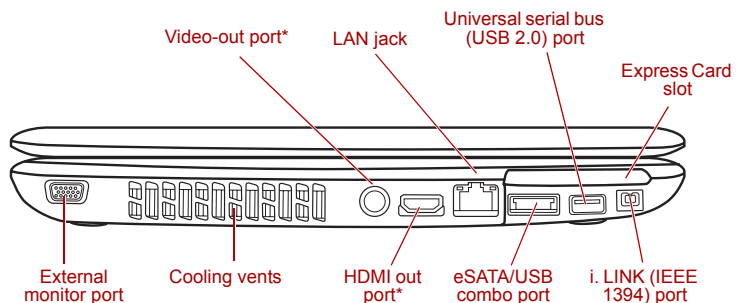

* Depending on the model you purchased.

Figure 2-2 The left side of the computer



External monitor port









This port allows you to connect an external monitor to the computer.

Cooling vents

The cooling vents help keep the processor from overheating.



Do not block the cooling vents. Keep foreign metal objects, such as screws, staples and paper clips, out of the cooling vents. Foreign metal objects can create a short circuit, which can cause damage and fire, possibly resulting in serious injury.

	Vide-out port	Plug a 4-pin S-Video connector into this port.
HDMI	HDMI out port	<p>HDMI out port can connect with Type A connector HDMI cable. One HDMI cable can send video and audio signals. In addition to this, it can send and receive control signals.</p> <p>By connecting a TV which supports HDMI Control to this port, the remote control for the connected TV can be used to operate some of the computer functions. Refer to the REGZA Link section in Chapter 8, <i>Optional Devices</i>, for more details.</p>
	LAN jack	<p>This jack lets you connect to a LAN. The adaptor has built-in support for Ethernet LAN (10 megabits per second, 10BASE-T), Fast Ethernet LAN (100 megabits per second, 100BASE-TX) and Gigabit Ethernet LAN (1000 megabits per second, 1000BASE-T). The LAN has two indicators. Refer to Chapter 4, <i>Operating Basics</i>, for details.</p>
	<ul style="list-style-type: none"> ■ Do not connect any cable other than a LAN cable to the LAN jack. It could cause damage or malfunction. ■ Do not connect the LAN cable to a power supply. It could cause damage or malfunction. 	
eSATA / 	eSATA/USB combo port	<p>This Universal Serial Bus port, which complies to the USB 2.0 standard, is provided on the left hand side of the computer. The ports with the icon () has USB Sleep and Charge function. This port has eSATA (External Serial ATA) function.</p>
	Universal Serial Bus (USB 2.0) port	<p>The Universal Serial Bus port, which complies with the USB 2.0 standard, is provided on the left hand side of the computer. The port with the icon () has <i>USB Sleep and Charge function</i>.</p>
	<p>Keep foreign metal objects, such as screws, staples and paper clips, out of the USB connectors. Foreign metal objects can create a short circuit, which can cause damage and fire, possibly resulting in serious injury.</p>	
	<p>Please note that it is not possible to confirm the operation of all functions of all USB devices that are available. In view of this it may be noted that some functions associated with a specific device might not operate properly.</p>	



ExpressCard slot

This slot allows you to install a single ExpressCard device.

Slim size remote controller is contained in the ExpressCard slot. Some models are equipped with a Slim size remote controller.



Keep foreign metal objects, such as screws, staples and paper clips, out of the ExpressCard slot and PC Card slot. Foreign metal objects can create a short circuit, which can cause damage and fire, possibly resulting in serious injury.



S400

i.LINK (IEEE1394) port

This port allows you to connect an external device, such as a digital video camera, to the computer for high-speed data transfer.

Right side

The following figure shows the computer's right side.

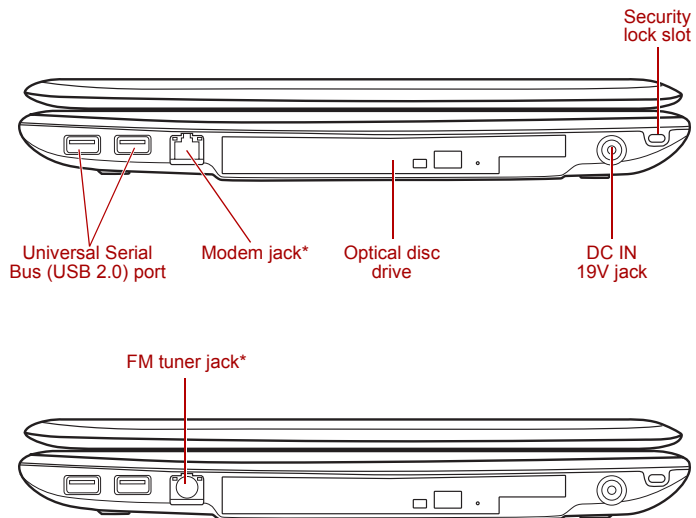

*Depending on the model you purchased.

Figure 2-3 The right side of the computer



Universal Serial Bus (USB 2.0) port

Two Universal Serial Bus ports, which comply with the USB 2.0 standard, are provided on the right side of the computer.



Modem jack

The modem jack allows you use to attach a modular cable in order to connect the internal modem directly to a telephone line.

Some models are equipped with a built-in modem.



- *Connection to any communication line other than an analog phone line could cause a computer system failure.*
 - *Connect the built-in modem only to ordinary analog phone lines.*
 - *Never connect the built-in modem to a digital line (ISDN).*
 - *Never connect the built-in modem to the digital connector on a public telephone or to a digital private branch exchange (PBX).*
 - *Never connect the built-in modem to a key telephone system for residences or offices.*
- *Avoid using your computer modem with the telephone cable connected during an electrical storm. There may be a remote risk of electric shock from lightning.*



FM tuner jack

A FM tuner jack enables FM tuner antenna connection. Some models are equipped with an FM tuner jack.

Optical disc drive

The computer is configured with a DVD Super Multi drive.



DC IN 19V jack

The AC adaptor connects to this jack in order to power the computer and charge its internal batteries. Please note that you should only use the model of AC adaptor supplied with the computer at the time of purchase - using the wrong AC adaptor can cause damage to the computer.



Security lock slot

A security cable can be attached to this slot and then connected to a desk or other large object in order to deter theft of the computer.

Back side

Figure 2-4 shows the computer's back side.



Figure 2-4 The computer's back side.

Underside

The following figure shows the underside of the computer. You should ensure that the display is closed before the computer is turned over to avoid causing any damage.

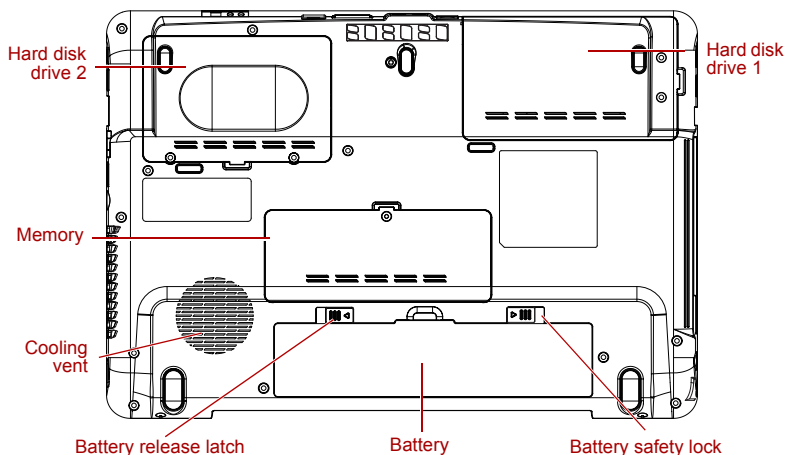
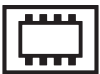
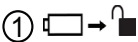

Figure 2-5 The underside of the computer



Memory module slots

The memory module slots are located here. The memory module slots allow for the installation, replacement and removal of additional memory modules. Please refer to the [Additional memory module](#) section in Chapter 8, [Optional Devices](#) for more information.



Battery safety lock

Slide this latch into its 'Unlock' position in order to release the battery pack ready for removal.

②

**Battery release latch**

Slide and hold this latch into its 'Unlock' position in order to release the battery pack ready for removal.

For more detailed information on removing the battery pack please refer to Chapter 6, [Power and Power-up Modes](#).

Battery pack

The battery pack provides power to the computer when the AC adaptor is not connected. For more detailed information on the use and operation of the battery pack please refer to Chapter 6, [Power and Power-up Modes](#).

Cooling vents

The computer's cooling vents help keep the processor from overheating.

Front with the display open

This section shows the computer with the display panel open. In order to open the display, lift the display panel up and position it at a comfortable viewing angle for you.

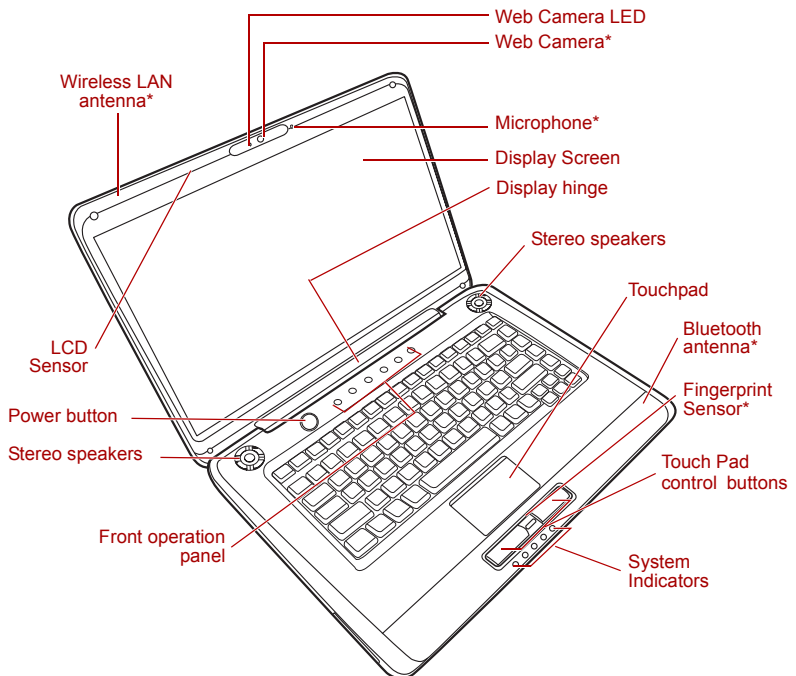

*Depending on the model you purchased.

Figure 2-6 The front of the Touch Pad model with the display open

harman/kardon

Display hinge	The display hinge allows the display panel to be position at a variety of easy-to-view angles.
Stereo speakers	The speakers emit sound generated by your software as well as audio alarms, such as low battery condition, generated by the system.



Keep foreign objects out of the speakers. Never allow metal objects, such as screws, staples and paper clips, to enter the computer or keyboard. Foreign metal objects can create a short circuit, which can cause computer damage and fire, possibly resulting in serious injury.

Display screen	Please be aware that, when the computer is operating on the AC adaptor, the image displayed on the internal screen will be somewhat brighter than when it operates on battery power. This difference in brightness levels is intended to save power when operating on batteries. For more information on the computer's display, please refer to the Display Controller section in Appendix B.
-----------------------	--

Front operation panel (six panels)	Six panels are available for use: Mute, CD/DVD, Play/Pause, Stop, Previous, Next. These panels allow you to manage Audio/Video, run applications and access utilities.
---	--



Power button	Press this button to turn the computer's power on and off.
---------------------	--

Touch Pad	The Touch Pad mouse control device located in the center of the palm rest is used to control the movement of the on-screen pointer. For more information, please refer to the Using the Touch Pad section in Chapter 4, Operating Basics .
------------------	--

Touch Pad control buttons	The control buttons located below the Touch Pad allow you to select menu items or manipulate text and graphics as designated by the on-screen pointer.
----------------------------------	--

Fingerprint Sensor	This sensor enables you to enroll and recognize a fingerprint. For detailed information on Fingerprint Sensor, refer to Chapter 4, Using the Fingerprint Sensor . Some models are equipped with an Fingerprint Sensor.
---------------------------	--

System indicators	These LED indicators allow you to monitor the status of various computer functions and are described in more detail within the System indicators section.
Web Camera	<p>Web Camera is a device that allows you to record video or take photographs with your computer. You can use it for video chatting or video conferences using a communication tool such as Windows Live Messenger. Camera Assistant Software will help you to add various video effects to your video or photograph.</p> <p>Enables the transmission of video and use of video chat via the internet using specialized applications.</p> <p>The effective pixel count for this web camera is 1.3 million and 0.3million (0.3M maximum photograph size: 640X480 pixels; 1.3M maximum photograph size: 1280X1024 pixels). Please remove the protective plastic-film before using the Web Camera.</p> <p>Please refer to the Web Camera section in Chapter 4, Operating Basics.</p>
Web Camera LED	<p>The Web Camera LED glows when the Web Camera is operating.</p> <p>Please remove the protective plastic-film before using the Web Camera.</p>
LCD Sensor switch	<p>This switch senses when the display panel is either closed or opened and activates the Panel Power Off/On feature as appropriate. For example, when you close the display panel the computer enters Hibernation Mode and shuts itself down and then, when you next open the display, the computer will automatically start up and return you to the application you were previously working on.</p> <p>You can specify within the Power Options. To access it, click Start -> Control Panel -> System and Maintenance -> Power Options.</p>



Do not put any magnetic objects close to this switch as they may cause the computer to automatically enter Hibernation Mode and shut down even if the Panel Power Off feature is disabled.

Microphone	A built-in microphone allows you to import and record sounds for your application - please refer to the Sound system section in Chapter 4, Operating Basics for more information.
-------------------	---

Function button

Six buttons are provided with some models.

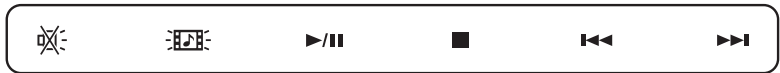







Figure 2-7 Front operation panel

Available for use: Mute, CD/DVD, Play/Pause, Stop, Previous, Next.

These buttons allow you to manage audio/video, run applications and access utilities. Refer to the [Function button](#) section in Chapter 4, [Operating Basics](#) for details.

Please handle your computer carefully to avoid scratching or damaging the surface.





	Mute button	Press this button to turn off the sound.
	CD/DVD button	Press this button to launch an application program that allows Windows Media Player / TOSHIBA DVD PLAYER.
	Play/Pause button	Press this button to begin playing an audio CD, a DVD movie or digital audio files. This button also acts as a Pause button.
	Stop	Press this button to stop play.
	Previous button	Press this button to advance to the previous track, chapter or data.
	Next button	Press this button to advance to the next track, chapter or data.

System indicators

The LED system indicators for specific computer operations glow when those operations are in progress.



Figure 2-8 System indicators

	DC IN	<p>The DC IN indicator normally glows white when power is being correctly supplied from the AC power adaptor. However, if the output voltage from the adaptor is abnormal, or if the computer's power supply malfunctions, this indicator will go out.</p>
	Power	<p>The Power indicator normally glows white when the computer is turned on. However, if you turn the computer off into Sleep Mode, this indicator will flash amber - approximately one second on, two seconds off - both while the system is shutting down and while it remains turned off.</p>
	Battery	<p>The Battery indicator shows the condition of the battery's charge - white indicates the battery is fully charged, amber indicates the battery is charging, and flashing amber indicates a low battery condition. Please refer to Chapter 6, Power and Power-up Modes for more information on this feature.</p>
	HDD/ODD/eSATA	<p>The HDD/ODD/eSATA indicator glows white whenever the computer is accessing the built-in hard disk drive or the other drives.</p>
	Bridge media slot	<p>The Bridge media slot indicator glows white when the computer is accessing the Bridge media slot.</p>

Keyboard indicators

The following figures show the positions of the CAPS LOCK indicator and the keypad overlay indicators which show the following conditions:

- When the CAPS LOCK indicator glows, the keyboard will produce capitals when any letter is typed.
- When the Arrow Mode indicator glows, the keypad overlay allows you to use cursor functions.
- When the Numeric Mode indicator glows, the keypad overlay allows you to enter numbers.

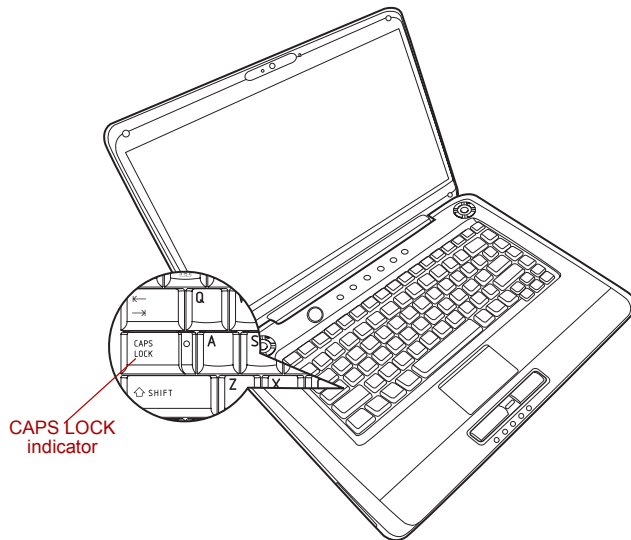



Figure 2-9 Keypad indicators

	<p>CAPS LOCK This indicator glows green when letter keys are locked into their uppercase format.</p>
	<p>Arrow Mode When the Arrow Mode indicator lights green, you can use the gray labeled keys on the keypad overlay as cursor keys. Please refer to the Keypad overlay section in Chapter 5, <i>The Keyboard</i> for more information.</p>
	<p>Numeric Mode When the Numeric Mode indicator lights green, you can use the gray labeled keys on the keypad overlay for number entry. Please refer to the Keypad overlay section in Chapter 5, <i>The Keyboard</i> for more information.</p>

Optical disc drives

The computer is configured with a DVD Super Multi drive. A Serial ATA interface controller is used for CD/DVD-ROM operation. When the computer is accessing a CD/DVD, an indicator on the drive glows. For further information on loading and unloading discs, please refer to the Writing CD/DVD on DVD Super Multi drives section in Chapter 4, [Operating Basics](#).

Region codes for DVD drives and media

DVD Super Multi drives and their associated media are manufactured according to the specifications of six marketing regions. When you purchase DVD-Video, make sure it matches your drive, otherwise it will not play properly.

Code	Region
1	Canada, United States
2	Japan, Europe, South Africa, Middle East
3	South East Asia, East Asia
4	Australia, New Zealand, Pacific Islands, Central America, South America, Caribbean
5	Russia, Indian Subcontinent, Africa, North Korea, Mongolia
6	China

Writable discs

This section describes the types of writable CD/DVD discs. Check the specifications of your drive to see the types of discs it can write. Use TOSHIBA Disc Creator to write compact discs. Please refer to Chapter 4, [Operating Basics](#) for further information.

CDs

- CD-R discs can be written only once. The recorded data cannot be erased or changed.
- CD-RW discs including multi speed CD-RW discs, high-speed CD-RW discs and ultra-speed CD-RW discs can be recorded more than once.

DVDs

- DVD-R, DVD+R, DVD-R (Dual Layer) and DVD+R (Double Layer) discs can be written only once. The recorded data cannot be erased or changed.
- DVD-RW, DVD+RW and DVD-RAM discs can be recorded more than once.



Some types and formats of DVD-R (Dual Layer) and DVD+R (Double Layer) discs may be unreadable.

DVD Super Multi drive

The full-size DVD Super Multi drive module allows you to record data to recordable CD's and DVD's as well as run either 12cm (4.72") CD's, and DVD's, and 8cm (3.15") CD's and DVD's without using an adaptor.



The speed is slower at the center of a disc and faster at the outer edge.

DVD read	<i>8 speed (maximum)</i>
DVD-R write	<i>8 speed (maximum)</i>
DVD-R DL write	<i>6 speed (maximum)</i>
DVD-RW write	<i>6 speed (maximum)</i>
DVD+R write	<i>8 speed (maximum)</i>
DVD+R DL write	<i>6 speed (maximum)</i>
DVD+RW write	<i>8 speed (maximum)</i>
DVD-RAM write	<i>5 speed (maximum)</i>
CD read	<i>24 speed (maximum)</i>
CD-R write	<i>24 speed (maximum)</i>
CD-RW write	<i>24 speed (maximum, Ultra-speed media)</i>

Remote Controller

A remote controller, enables you to perform some functions of your computer from a distant location.

The following figure shows the buttons on the Remote Controller.

You can use your Remote Controller with Media Center to play CDs, DVDs and videos, and view pictures.

Using the Remote Controller, you can:

- Navigate and control all Media Center windows.
- Control the video display.
- Place the computer in and out of Sleep Mode.

Refer to the [Using the Remote Controller](#) section in this chapter for information on how to use the Remote Controller as well as how to install and remove its batteries.

Slim Size Remote Controller

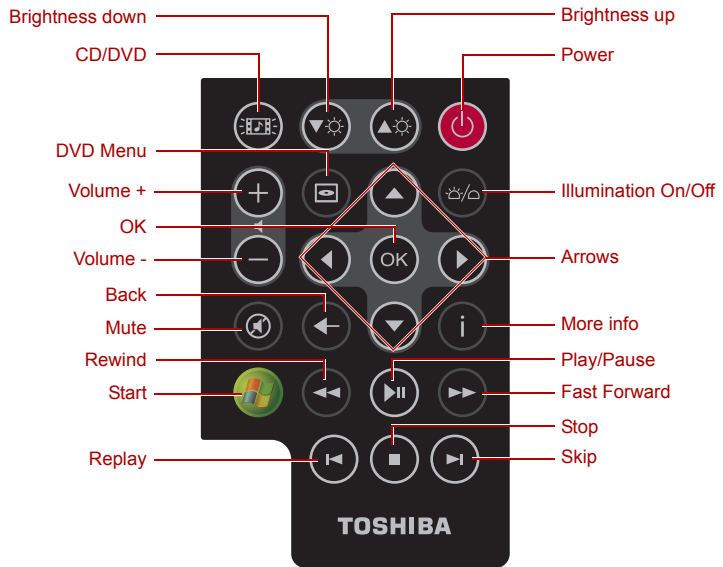

Figure 2-10 Slim Size Remote Controller



CD/DVD

Pressing this button will launch an application program that allows you to watch a DVD or listen to a CD.

Pressing this button while the computer is on or in Sleep Mode, will launch Media Center. My Music is started when a music CD is inserted in the optical disc drive and My Video is started when a DVD video is in the drive. If the application you wish to run is not selected as the active window when these buttons are pressed, please switch to the application manually. For example, by clicking the taskbar item for the application window you wish to make active.













Brightness down

Decreases the computer's display panel brightness in individual steps.



Brightness up

Increases the computer's display panel brightness in individual steps.

	Power	Starts or terminates the operating system. This button functions like the Power button of your computer. By default, the Sleep Mode is equivalent to the Power Off state of your computer. To change the setting, click Start , select Control panel -> System and Maintenance -> Power Options . The following four options are available: Do nothing, Sleep, Hibernate and Shut down
	Volume +	Increases the volume while viewing DVD's or replaying CD's.
	Volume -	Decreases the volume while viewing DVD's or replaying CD's.
	DVD Menu	Opens the main menu on a DVD movie, if available.
	Arrows	Moves the cursor to navigate within Media Center windows.
OK	OK	Selects the desired action or window option. It acts like the ENTER Key.
	Illumination On/Off	Pressing this button to switch the lighting of indicators (e.g. Front operation panel, power button, etc).
	Mute	Turns your computer sound off.
	Back	Displays the previous window.
	More Info	This button has the same function as the secondary (right) mouse button.
	Start	Opens Media Center to the main window.
	REW (Rewind)	Moves the media (video, DVD, music, and so on) backwards.
	Play/Pause	Plays the selected media. Pauses an audio or video track.
	FWD (Fast Forward)	Moves the media (video, DVD, music, and so on) forwards.
	Replay	Moves media backward (seven seconds for videos, one music track or one DVD chapter at a time).

■	Stop	Stops the media currently playing.
▶	Skip	Moves media forward (30 seconds for videos, one music track or one DVD chapter).

Using the Remote Controller

Some computers include a remote control unit, which allows you to control some of your computer's functions from a distant location.



- *The Remote Controller is designed specifically for this computer.*
- *Some application programs may not support remote control functions.*

Operational range of the Remote Controller

Point the Remote controller at your computer and press a button. The operational angle and distance are described below.

Distance	Within 5 m from the infrared receiver window.
Angle	Within a 30 degree horizontal and 15 degree vertical range of the infrared receiver window.

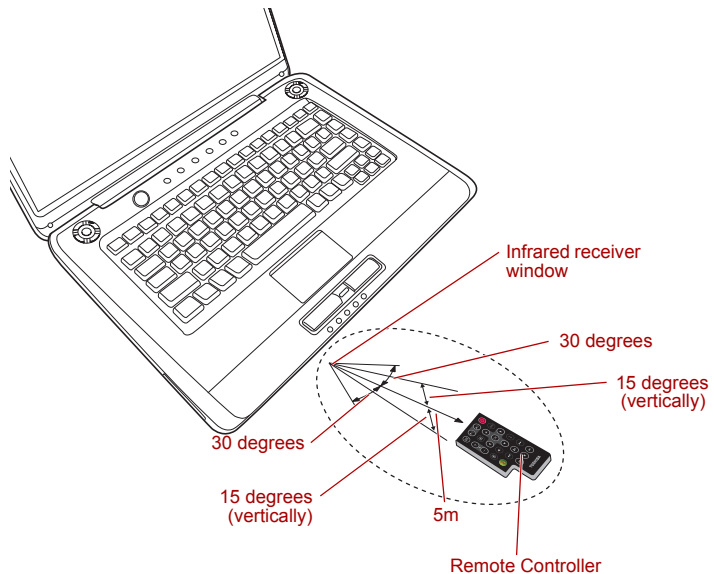

Figure 2-11 Operational range of the remote control

* The appearance of the provided Remote Controller may vary from model to model.



Even if within the effective scope as described above, the remote control may malfunction or not work correctly in the following cases.

- *When an obstacle stands between the infrared receiver window of your computer and the Remote Controller.*
- *When direct sunlight or strong fluorescent light strikes the infrared receiver window.*
- *When the infrared receiver window or the infrared emission part of the Remote Controller is dirty.*
- *When other computers which use an infrared remote controller are used near to your computer.*
- *When a low battery condition is present.*

Installing/Removing batteries

Be sure to install the provided CR2016 type batteries before using the remote controller.



Store the battery for the remote control beyond the reach of children.

If a child swallows a battery, this might result in choking. If it happens, contact a doctor immediately.



Observe the following precautions when using the battery of the Remote Controller.

- *Do not use batteries other than those specified.*
- *Ensure that you insert the batteries with their polarities correctly aligned (+ or -).*
- *Do not recharge, heat, disassemble or short the battery, or put it into a fire or flame.*
- *Do not use a battery whose 'recommended expiration date' has been reached, or which is completely discharged.*
- *Do not use different types of batteries or old and new batteries at the same time.*
- *Do not carry the battery together with metal necklaces, hairpins or other metal accessories.*
- *When storing or disposing of used batteries, make sure to put some insulation tape on their terminals (+ and -) to avoid short-circuits.*

If these precautions are not followed, heating, fluid leakage or explosion may occur. This may cause burns or personal injury. If battery fluid gets on your skin or clothes, wash immediately with clean water. If battery fluid gets in your eyes, rinse your eyes with clean water immediately and see a doctor. Do not touch the battery fluid on instruments or devices with bare hands. Wipe off with a cloth or paper towel.

Type of battery that can be used for the Remote Controller

When the batteries shipped with the Remote Controller are discharged, replace them with commercially available CR2016 Lithium batteries. Other types or battery should not be used.

Slim size remote controller

Installing the battery

1. Open the battery cover on the back side of the remote controller.

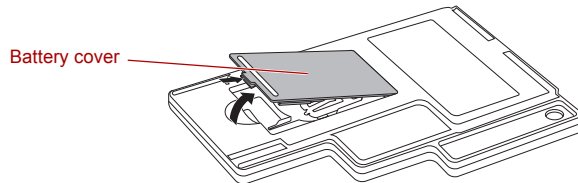

Figure 2-12 Opening the battery cover

2. Be sure to place the battery with correct polarities. Press the battery down to the stopper then push it forward to fit into the battery case.

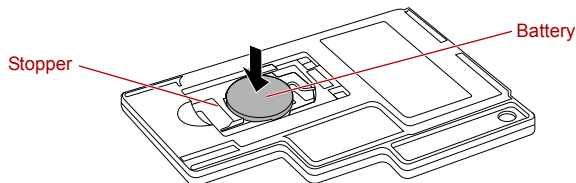

Figure 2-13 Inserting the battery

3. Close the battery cover. Close the cover securely until it clicks.

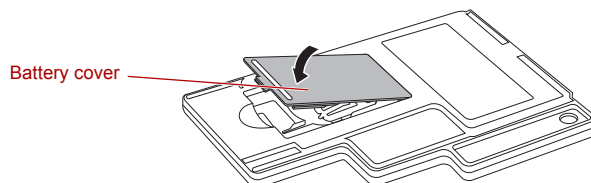

Figure 2-14 Closing the battery cover

Replacing the battery

1. Open the battery cover on the back side of the remote controller.
2. Hold down the stopper and slide the battery out of battery case.

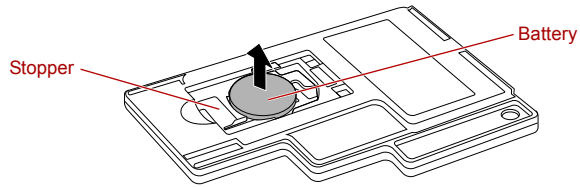

Figure 2-15 Removing the batteries

3. Insert the battery in place. Be sure to place the batteries with correct polarities. Press the battery down to the stopper then push it forward to fit into the battery case.
4. Close the battery cover. Close the cover securely until it clicks.

Placing Slim size remote controller

Inserting a Slim size remote controller

To insert a Slim size remote controller, follow the steps as detailed below:

1. Make sure the ExpressCard slot is empty.
2. Set the front side upward and insert a Slim size remote controller.

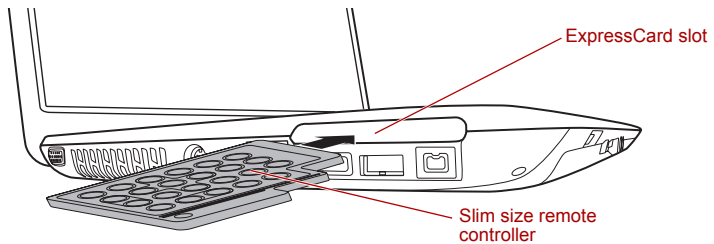

Figure 2-16 Inserting a Slim size remote controller

3. Press a Slim size remote controller gently to ensure a firm connection is made.

Removing a Slim size remote controller

To remove a Slim size remote controller, follow the steps as detailed below:

1. Press a Slim size remote controller slightly to make it stretch out.
2. Grasp a Slim size remote controller and pull it out from the slot.

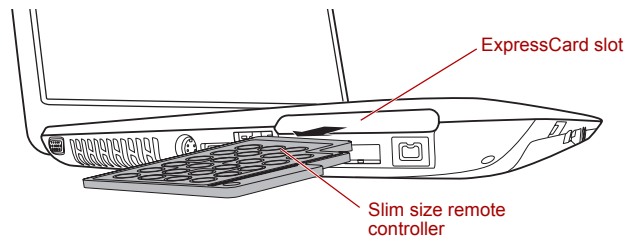

Figure 2-17 Removing a Slim size remote controller

AC adaptor

The AC adaptor can automatically adjust to any voltage ranging from 90 to 264 volts and to a frequency of either 47 or 63 hertz, enabling you to use this computer in almost any country/region. The adaptor converts AC power to DC power and reduces the voltage supplied to this computer.

To recharge the battery, simply connect the AC adaptor to a power source and to the computer. Please refer to Chapter 6, [Power and Power-up Modes](#) for further information.

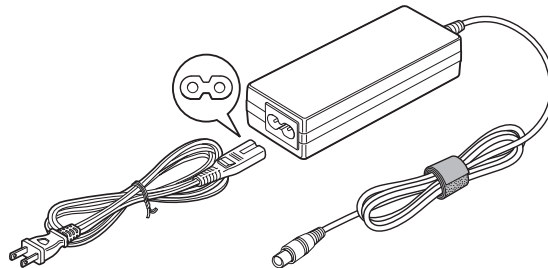

Figure 2-18 The AC adaptor (2-pin plug)

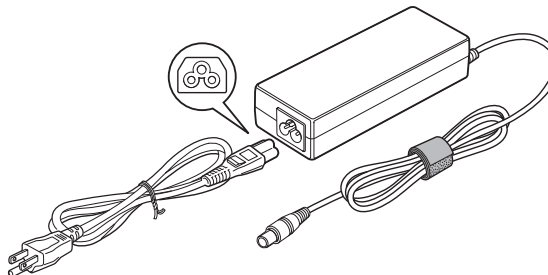

Figure 2-19 The AC adaptor (3-pin plug)



- *Depending on the model in question, either a 2-pin or 3-pin adaptor/power lead will be bundled with the computer.*
- *Do not use a 3-pin to 2-pin conversion plug.*
- *The supplied power cord conforms to safety rules and regulations in the region the product is bought and should not be used outside of this region. In order to use the adaptor/computer in other regions, you should please buy a power cord that conforms to the safety rules and regulations in that particular region.*



Always use the TOSHIBA AC adaptor that was included with your computer, or use AC adaptors specified by TOSHIBA to avoid any risk of fire or other damage to the computer. Use of an incompatible AC adaptor could cause fire or damage to the computer possibly resulting in serious injury.

Chapter 3

Getting Started

This chapter provides basic information to start using your computer. It covers the following topics:



- *If the battery pack is not pre-installed in the computer that you purchased, please install the battery pack before you start using the computer. Please refer to Chapter 6-9, [Replacing the battery pack](#) for further information about installing the battery pack.*
- *All users should be sure to read the section [Starting up for the first time](#).*
- *Be sure to read the enclosed Instruction Manual for Safety and Comfort for information on the safe and proper use of this computer. It is intended to help you be more comfortable and productive while using a notebook computer. By following the recommendations in it you may reduce your chance of developing a painful or disabling injury to your hand, arms, shoulders or neck.*
- Connecting the AC adaptor
- Opening the display
- Turning on the power
- Starting up for the first time
- Turning off the power
- Restarting the computer
- System Recovery Options
- Creating Optical Recovery Discs
- Restoring the pre-installed software from the Recovery hard disk drive
- Restoring the pre-installed software from your created Recovery Discs



- *Use a anti-virus software and make sure it is updated regularly.*
- *Never format storage media without checking its content - formatting destroys all stored data.*
- *It is a good idea to periodically back up the internal hard disk drive or other main storage device to external media. General storage media is not durable or stable over long periods of time and under certain conditions may result in data loss.*
- *Before you install a device or application, save any data in memory to the hard disk drive or other storage media. Failure to do so may result in the loss of data.*

Connecting the AC adaptor

Attach the AC adaptor when you need to charge the battery or you want to operate from AC power. It is also the fastest way to get started, because the battery pack will need to be charged before you can operate from battery power.

The AC adaptor can be connected to any power source supplying from 90 to 264 volts and 47 or 63 hertz. For details on using the AC adaptor to charge the battery pack, refer to Chapter 6, [Power and Power-up Modes](#).



- *Always use the TOSHIBA AC adaptor that was included with your computer or use AC adaptors specified by TOSHIBA to avoid any risk of fire or other damage to the computer. Use of an incompatible AC adaptor could cause fire or damage to the computer possibly resulting in serious injury. TOSHIBA assumes no liability for any damage caused by use of an incompatible adaptor.*
- *Never plug the AC adaptor into a power source that does not correspond to both the voltage and the frequency specified on the regulatory label of the unit. Failure to do so could result in a fire or electric shock, possibly resulting in serious injury.*
- *Always use or purchase power cables that comply with the legal voltage and frequency specifications and requirements in the country of use. Failure to do so could result in a fire or electric shock, possibly resulting in serious injury.*
- *The supplied power cord conforms to safety rules and regulations in the region the product is bought and should not be used outside this region. For use in other regions, please buy power cords that conform to safety rules and regulations in the particular region.*
- *Do not use a 3-pin to 2-pin conversion plug.*
- *When you connect the AC adaptor to the computer, always follow the steps in the exact order as described in the User's Manual. Connecting the power cable to a live electrical outlet should be the last step otherwise the adaptor DC output plug could hold an electrical charge and cause an electrical shock or minor bodily injury when touched. As a general safety precaution, avoid touching any metal parts.*
- *Never place your computer or AC adaptor on a wooden surface, furniture, or any other surface that could be marred by exposure to heat since the computer base and AC adaptor's surface increase in temperature during normal use.*
- *Always place your computer or AC adaptor on a flat and hard surface that is resistant to heat damage.*

Refer to the enclosed Instruction Manual for Safety and Comfort for detailed precautions and handling instructions.

1. Connect the power cord to the AC adaptor.

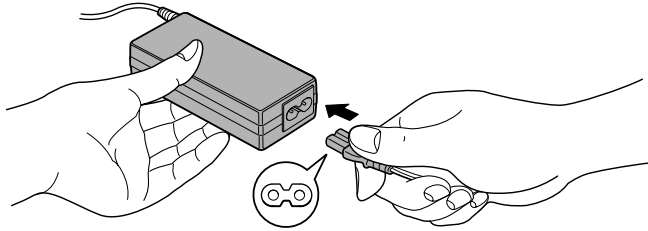

Figure 3-1 Connecting the power cord to the AC adaptor (2-pin plug)

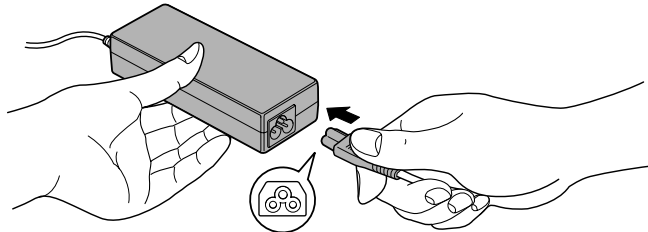

Figure 3-2 Connecting the power cord to the AC adaptor (3-pin plug)



Either a 2-pin or 3-pin adaptor/cord will be included with the computer depending on the model.

2. Connect the AC adaptor's DC output plug to the DC IN 19V jack on the right side of the computer.

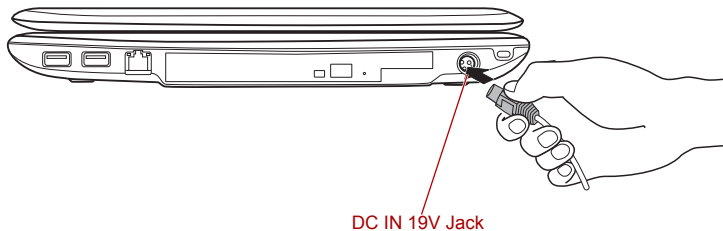

Figure 3-3 Connecting the adaptor to the computer

3. Plug the power cord into a live wall outlet - the **Battery** and **DC IN** indicators on the front of the computer should glow.

Opening the display

The display panel can be opened to a wide range of angles for optimal viewing.

While holding down the palm rest with one hand so that the main body of the computer is not raised, slowly lift the display panel - this will allow the angle of the display panel to be adjusted to provide optimum clarity.

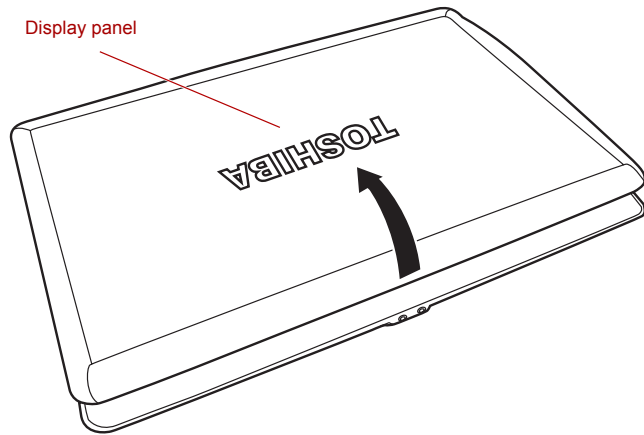

Figure 3-4 Opening the display



Use reasonable care when opening and closing the display panel. Opening it vigorously or slamming it shut could damage the computer.



- *As the display panel cannot be flipped to 180 degrees, please be careful of the angle when flipping open the display panel.*
- *Be careful not to open the display panel too far as this could put stress on the display panel's hinges and cause damage.*
- *Do not press or push on the display panel.*
- *Do not lift the computer by the display panel.*
- *Do not close the display panel with pens or any other objects left in between the display panel and the keyboard.*
- *When opening or closing the display panel, place one hand on the palm rest to hold the computer in place and use the other hand to slowly open or close the display panel (Do not use excessive force when opening or closing the display panel).*

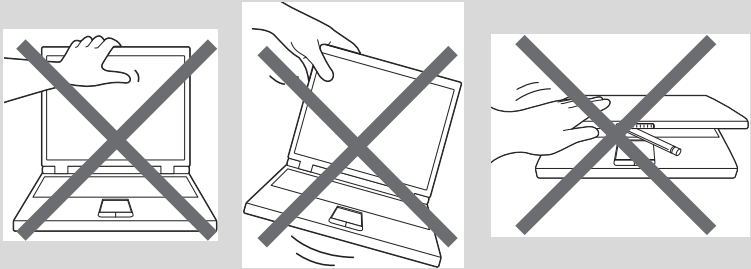

Turning on the power

This section describes how to turn on the power - the **Power** indicator will then indicate the status. Please refer to the Monitoring of power condition section in Chapter 6, [Power and Power-up Modes](#) for more information.



- *After you turn on the power for the first time, do not turn it off until you have set up the operating system. Please refer to the section [Starting up for the first time](#) for more information.*
- *Volume cannot be adjusted during Windows Setup.*

1. Open the computer's display panel.
2. Press the computer's power button.

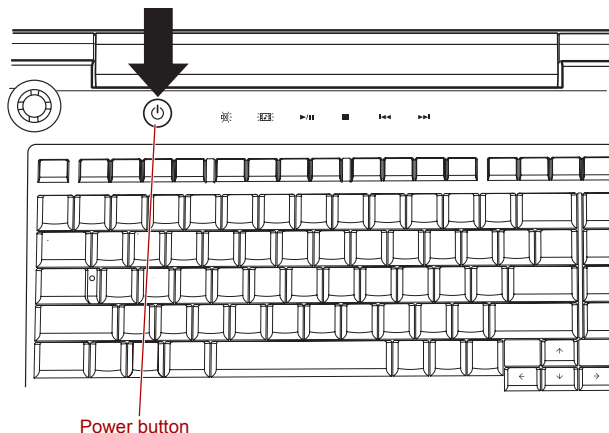

Figure 3-5 Turning on the power

Starting up for the first time

The Microsoft Windows Vista® Startup Screen will be the first screen displayed when you turn on the power. Follow the on-screen instructions on each screen in order to properly install the operating system.



*When it is displayed, be sure to read the **Software License Terms** carefully.*

Turning off the power

The power can be turned off in one of three modes, either Shut Down Mode, Hibernation Mode or Sleep Mode.

Shut Down Mode

When you turn off the power in Shut Down Mode no data will be saved and the computer will boot to the operating system's main screen the next time it is turned on.

1. If you have entered data, either save it to the hard disk drive or to other storage media.
2. Make sure all disk/disc activity has stopped before removing the CD/DVD or floppy diskette.

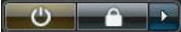

- *Make sure the **Hard Disk Drive** indicator is off. If you turn off the power while a disk (disc) is being accessed, you may lose data or damage the disk.*
- *Never turn off the power while an application is running. Doing so could cause loss of data.*
- *Never turn off the power, disconnect an external storage device or remove storage media during data read/write. Doing so can cause data loss.*

3. Click **Start**.
4. Click the arrow button () located in the power management buttons () and select **Shut Down** from the menu.
5. Turn off any peripheral devices connected to your computer.



Do not turn the computer or peripheral devices back on immediately - wait a short period to avoid any potential damage.

Hibernation Mode

The Hibernation Mode feature saves the contents of memory to the hard disk drive when the computer is turned off so that, the next time it is turned on, the previous state is restored. Please note that the Hibernation Mode feature does not save the status of any peripheral devices connected to the computer.



- *Save your data. While entering Hibernation Mode, the computer saves the contents of memory to the hard disk drive. However, for safety sake, it is best to save your data manually.*
- *Data will be lost if you remove the battery or disconnect the AC adaptor before the save is completed. Wait for the **Hard Disk Drive** indicator to go out.*
- *Do not install or remove a memory module while the computer is in Hibernation Mode. Data will be lost.*

Benefits of Hibernation Mode

The Hibernation Mode feature provides the following benefits:



- Saves data to the hard disk drive when the computer automatically shuts down because of a low battery condition.
- You can return to your previous working environment immediately when you turn on the computer.
- Saves power by shutting down the system when the computer receives no input or hardware access for the time period set by the System Hibernate feature.
- Allows the use of the panel power off feature.

Starting Hibernation Mode



You can also enable Hibernation Mode by pressing **FN + F4** - please refer to Chapter 5, [The Keyboard](#), for further details.

To enter Hibernation Mode, follow the steps below.

1. Click **Start**.
2. Click the arrow button () in the power management buttons () and select **Hibernate** from the menu.

Automatic Hibernation Mode

The computer can be configured to enter Hibernation Mode automatically when you press the power button or close the lid. In order to define these settings, you can follow the steps as described below:

1. Click **Start** and click the **Control Panel**.
2. Click **System and Maintenance** and click **Power Options**.
3. Click **Choose what the power button does** or **Choose what closing the lid does**.
4. Enable the desired Hibernation Mode settings for **When I press the power button** and **When I close the lid**.
5. Click the **Save changes** button.

Data save in Hibernation Mode

When you turn off the power in Hibernation Mode, the computer will take a moment to save the current data in memory to the hard disk drive. During this time, the **Hard Disk Drive** indicator will glow.

After you turn off the computer, and the content of memory has been saved to the hard disk drive, turn off the power to any peripheral devices.



Do not turn the computer or devices back on immediately. Wait a moment to let all capacitors fully discharge.

Sleep Mode

If you have to interrupt your work, you are able to turn off the power without exiting from your software by placing the computer into Sleep Mode. In this mode data is maintained in the computer's main memory so that when you turn on the power again, you can continue working right where you left off.



When you have to turn off your computer aboard an aircraft or in places where electronic devices are regulated or controlled, always completely shut down the computer. This includes turning off any wireless communication switches or devices, and canceling settings that reactivate the computer automatically, such as a timer recording function. Failure to completely shut down the computer in this way could allow the operating system to reactivate and run pre-programmed tasks or preserve unsaved data, which could interfere with aviation or other systems, possibly causing serious injury.



- Before entering Sleep Mode, be sure to save your data.
- Do not install or remove a memory module while the computer is in Sleep Mode. The computer or the memory module could be damaged.
- Do not remove the battery pack while the computer is in Sleep Mode (unless the computer is connected to an AC power source). Data in memory could be lost.



- When the AC adaptor is connected, the computer will go into Sleep Mode according to the settings in the Power Options (to access it, **Start** -> **Control Panel** -> **System and Maintenance** -> **Power Options**).
- To restore the operation of the computer from Sleep Mode, press and hold the power button or any key on the keyboard for a short amount of time. Please note that keyboard keys can only be used if the Wake-up on Keyboard option is enabled within the HW Setup utility.
- If the computer enters Sleep Mode while a network application is active, the application might not be restored when the computer is next turned on and the system returns from Sleep Mode.
- To prevent the computer from automatically entering Sleep Mode, disable Sleep Mode within the Power Options (to access it, **Start** -> **Control Panel** -> **System and Maintenance** -> **Power Options**).
- To use the Hybrid Sleep function, configure it in the Power Options.

Benefits of Sleep Mode

The Sleep Mode feature provides the following benefits:



- Restores the previous working environment more rapidly than does the Hibernation Mode feature.
- Saves power by shutting down the system when the computer receives no input or hardware access for the time period set by the System Sleep Mode feature.
- Allows the use of the panel power off feature.

Executing Sleep Mode



You can also enable Sleep Mode by pressing **FN + F3** - please refer to Chapter 5, [The Keyboard](#), for further details.

You can enter Sleep Mode in one of four ways:

- Click **Start** then click the power button () located in the power management buttons (). Please note that this feature must be enabled within the Power Options (to access it, click **Start** -> **Control Panel** -> **System and Maintenance** -> **Power Options**).
- Click **Start** then click the arrow button () and select **s1eeP** from the menu.

- Close the display panel. Please note that this feature must be enabled within the Power Options (to access it, click **Start** -> **Control Panel** -> **System and Maintenance** -> **Power Options**).
- Press the power button. Please note that this feature must be enabled within the Power Options (to access it, click **Start** -> **Control Panel** -> **System and Maintenance** -> **Power Options**).

When you turn the power back on, you can continue where you left when you shut down the computer.



- *When the computer is in Sleep Mode, the **Power** indicator will blink amber.*
- *If you are operating the computer on battery power, you can lengthen the overall operating time by turning it off into Hibernation Mode - Sleep Mode will consume more power while the computer is off.*

Sleep Mode limitations

Sleep Mode will not function under the following conditions:



- Power is turned back on immediately after shutting down.
- Memory circuits are exposed to static electricity or electrical noise.

Restarting the computer

Certain conditions require that you reset the computer, for example if:

- You change certain computer settings.
- An error occurs and the computer does not respond to your keyboard commands.

If you need to restart the computer, there are three ways this can be achieved:

- Click **Start** then click the arrow button () in the power management buttons () and select **Restart** from the menu.
- Press **CTRL**, **ALT** and **DEL** simultaneously (once) to display the menu window, then select **Restart** from the **Shut down options**.
- Press the power button and hold it down for four seconds. Once the computer has turned itself off, wait between ten and fifteen seconds before turning the power on again by pressing the power button.

System Recovery Options

About 1.5GB hidden partition is allocated on the hard disk drive for the System Recovery Options.

This partition stores files which can be used to repair the system in the event of a problem.



The System Recovery Options feature will be unusable if this partition is deleted.

System Recovery Options

The System Recovery Options feature is installed on the hard disk when shipped from the factory. The System Recovery Options menu includes tools to repair startup problems, run diagnostics or restore the system.

See the **Windows Help and Support** content for more information about **Startup Repair**.

The System Recovery Options can also be run manually to repair problems.

The procedure is as follows. Follow the instructions shown on the on-screen menu.

1. Turn off the computer.
2. While holding the **F8** key, turn on the computer.
3. The **Advanced Boot Options** menu will be displayed. Use the arrow keys to select **Repair Your Computer** and press **ENTER**.
4. Follow the on-screen instructions.



The Windows Vista® CompletePC Backup feature can be used on Windows Vista® Business Edition and Ultimate Edition.

Creating Optical Recovery Discs

This section describes how to create Recovery Discs.



- *Be sure to connect the AC adaptor when you create Recovery Discs.*
- *Be sure to close all other software programs except the Recovery Disc Creator.*
- *Do not run software such as screen savers which can put a heavy load on the CPU.*
- *Operate the computer at full power.*
- *Do not use power-saving features.*
- *Do not write to the disc when the anti-virus software is running. Wait for it to finish, then disable virus detection programs including any software that checks files automatically in the background.*
- *Do not use utilities, including those intended to enhance hard disk drive access speed. They may cause unstable operation and damage data.*
- *Do not shut down/log off or Sleep/Hibernate while writing or rewriting the disc.*
- *Set the computer on a level surface and avoid places subjected to vibrations such as airplanes, trains, or cars.*
- *Do not use on unstable tables or other any other unstable surfaces.*

A recovery image of the software on your computer is stored on the hard disk drive, and can be copied to DVD media by using the following steps:

1. Select either blank DVD media.
2. The application will allow you to choose from a variety of different media onto which the recovery image can be copied including DVD-R, DVD-R DL, DVD-RW, DVD+R, DVD+R DL and DVD+RW.



Please note that some of the above media may not be compatible with the optical disc drive installed into your computer. You should therefore verify the optical disc drive supports the blank media you have chosen before proceeding.

3. Turn on your computer and allow it to load the Windows Vista® operating system from the hard disk drive as normal.
4. Insert the first blank media into the optical disc drive tray.
5. Double click the **Recovery Disc Creator** icon on the Windows Vista® desktop, or select the application from **Start** Menu.
6. After Recovery Disc Creator starts, select the type of media and the title you wish to copy, and then click the **Create** button.

If your optical disc drive can only write to CDs, select 'CD' as the 'Disc Set' within the Recovery Disc Creator application. Otherwise, if your optical disc drive can write both CDs and DVDs, select the type of media you want to create.

Restoring the pre-installed software from the Recovery hard disk drive

A portion of the total hard disk drive space is configured as a hidden recovery partition. This partition stores files which can be used to restore pre-installed software in the event of a problem.

If you subsequently set up your hard disk drive again, do not change, delete or add partitions in a manner other than specified in the manual, otherwise you may find that space for the required software is not available.

In addition, if you use a third-party partitioning program to reconfigure the partitions on your hard disk drive, you may find that it becomes impossible to setup your computer.



When the sound mute feature has been activated by pressing the Mute panel (Fn+ESC), be sure to disable this to allow sounds to be heard before starting the restore process. Please refer to Chapter 5, [The Keyboard](#), for further details.

You can not use System Recovery Options if restoring the pre-installed software without System Recovery Options.



When you reinstall the Windows operating system, the hard disk will be reformatted and all data will be lost.

1. Turn off your computer.
2. While holding down **0** (zero) key on the keyboard, turn on your computer.
3. A menu will be displayed from which you should follow the on-screen instructions.

Restoring the pre-installed software from your created Recovery Discs

If the pre-installed files are damaged, you are able to either use the Recovery Discs you have created or the hard disk drive recovery process to restore the computer to the state it was in when you originally received it. To perform this restoration, follow the steps below:



*When the sound mute feature has been activated by pressing the **FN + ESC** key, be sure to disable this to allow sounds to be heard before starting the restore process. Please refer to Chapter 5, [The Keyboard](#), for further details.*

You can not use System Recovery Options if restoring the pre-installed software without System Recovery Options.



When you reinstall the Windows operating system, the hard disk will be reformatted and all data will be lost.

1. Load the Recovery Discs into the optical disc drive and turn off the computer's power.
2. While holding down **F12** key on the keyboard, turn on your computer - when **TOSHIBA Leading Innovation>>>** appears, release the **F12** key.

For 2HDD Model, If HDD1 is first, go to step 3. If HDD1 is not first, do as follows:

- Select **Enter Setup**.
 - Press the **F9** key to set to default settings, and select the **Yes**.
 - When the "**In Touch with Tomorrow TOSHIBA**" prompt appears, press the **F12** key to display the Boot menu. Continue with step 3.
3. Use the up and down cursors key to select the CD-ROM icon from the menu. Please refer to the [Boot Priority](#) section in Chapter 7, [HW Setup and Passwords](#) for further information.
 4. A menu will be displayed from which you should follow the on-screen instructions.



When removing pre-installed drivers / utilities or when installing, you can setup the respective drivers / utilities from the following folder.

*C : \TOSAPINS****

Chapter 4

Operating Basics

This chapter describes the basic operations of your computer, highlights the precautions that should be taken when using it.

Using the Touch Pad

To use the Touch Pad, simply touch and move your fingertip across it in the direction you want the on-screen pointer to go.

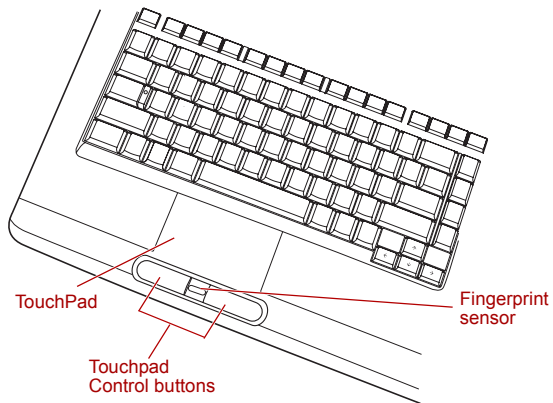

Figure 4-1 Touch Pad and Touch Pad control buttons

The two buttons below the Touch Pad are used like the buttons on a standard mouse - press the left button to select a menu item or to manipulate text or graphics designated by the pointer, and press the right button to display a menu or other function depending on the software you are using.



You can also tap the Touch Pad to perform functions similar to those of the left button on a standard mouse.

Click: Tap once

Double-click: Tap twice

Drag and drop: Tap to select the item(s) you want to move, leave your finger on the Touch Pad after the second tap and then move the item(s) to their new destination.

Using the Fingerprint Sensor

Some models has a fingerprint utility installed for the purpose of enrolling and recognizing fingerprints. By enrolling the ID and password onto the fingerprint authentication feature, it is no longer necessary to input the password from the keyboard. Fingerprint feature enables you to:

- Logon to Windows and access a security enabled homepage through Internet Explorer.
- Files and folders can be encrypted/decrypted and third party access to them prevented.
- Disable the password-protected screen-saver when returning from a power-saving mode such as Sleep Mode.
- Authentication of the User Password (and, if applicable, the HDD (Hard Disk Drive) Password) when booting up the computer (Pre-OS Authentication).
- Single-Swipe Sign On feature



Fingerprint cannot be used in models that do not have a fingerprint module installed.

How to Swipe your Finger

Using the following steps when swiping fingers for fingerprint registration or authentication will help to minimize authentication failures:

Align the first joint of the finger to the center of the sensor. Lightly touch the sensor and swipe finger levelly towards you until the sensor surface becomes visible. In performing this process, you should also take care to ensure that the center of your fingerprint is on the sensor.

The following illustrations show the recommended way to swipe your finger over the fingerprint sensor.

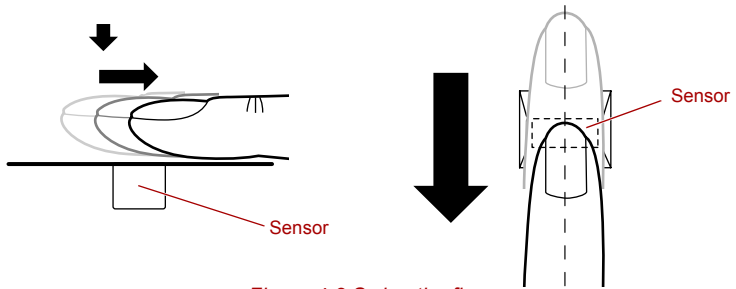

Figure 4-2 Swipe the finger



- *Avoid swiping with your finger stiff or pressed too hard onto the sensor, and take care to ensure that the center of the fingerprint is touching the sensor before swiping. Either of these conditions may cause fingerprint reading to fail.*
- *Check the center of the fingerprint whorl before swiping and then ensure this is swiped along the center line of the sensor.*
- *There is a possibility of authentication failures if the finger is swiped too quickly or too slowly - follow any on-screen instructions to adjust the speed used during the swipe process.*

Points to note about the Fingerprint Sensor

Please be aware of the following considerations when using the fingerprint sensor. A failure to follow these guidelines might result in damage to the sensor, sensor failure, fingerprint recognition problems or a lower fingerprint recognition success rate.

- Do not scratch or poke the sensor with your nails or any hard or sharp objects.
- Do not press the sensor strongly.
- Do not touch the sensor with a wet finger or any wet objects - keep the sensor surface dry and free from water vapor.
- Do not touch the sensor with a soiled or dirty finger as minute foreign particles of dust and dirt may scratch it.
- Do not paste stickers or write on the sensor.
- Do not touch the sensor with a finger or any other object which may have a build-up of static electricity on it.

Observe the following before you place your finger on the sensor whether for fingerprint enrollment/registration or recognition.

- Wash and dry your hands thoroughly.
- Remove static electricity from your fingers by touching any metal surface. Static electricity is a common cause of sensor failures, especially when the weather is dry.

- Clean the sensor with a lint-free cloth - do not use detergent or any other chemicals to clean the sensor.
- Avoid the following finger conditions for enrollment or recognition as they may result in fingerprint enrollment errors or a drop in the fingerprint recognition success rate
 - Soaked or swollen finger, for example as may occur after taking a bath.
 - Injured finger
 - Wet finger
 - Soiled or oily finger
 - Extremely dry skin condition on finger

Observe the following to improve the fingerprint recognition success rate.

- Enroll two or more fingers.
- Enroll additional fingers if a recognition failure often occurs when using already enrolled fingers.
- Check the condition of your finger - any conditions which have changed since enrollment, such as injury, rough skin, and extremely dry, wet, soiled, dirty, oily, soaked or swollen fingers, may lower the recognition success rate. Also if the fingerprint is worn down or the finger becomes thinner or fatter, the recognition success rate may be lowered.
- As the fingerprint for each finger is different and unique you should ensure that only the registered or enrolled fingerprint or fingerprints are used for identification.
- Check the position and speed at which you swipe your finger across the sensor - please refer to the preceding drawing.
- The fingerprint sensor compares and analyzes the unique characteristics in a fingerprint. However, there may be instances where certain users are unable to register their fingerprints due to insufficient unique characteristics in their fingerprints.
- The recognition success rate may differ from user to user.

Setup Procedure

Please use the following procedure when first using fingerprint authentication.

Fingerprint Registration

You should initially enroll the required authentication data using the **Fingerprint Enrollment Wizard**.



- *In use, the fingerprint authentication system will use the same username and password as defined within the Windows operating system. If no Windows password has been configured, you must do this before starting the fingerprint registration process.*
- *This sensor has the memory space for at least twenty-one fingerprint patterns. You might be able to register more fingerprint patterns depending on the sensor memory usage.*

1. To run this program, click **Start -> All Programs -> TrueSuite Access Manager -> TrueSuite Access Manager**.



You are also able to start the Fingerprint Enrollment Wizard by using the following methods.

- *Right-click the TrueSuite Access Manager icon in the Taskbar and choose Open.*
2. The **Verify** screen will be displayed, enter the Windows logon password and click the **Next** button.
 3. On the **User's Fingers** screen click the box above the finger you wish to register.
If any of the previously enrolled fingerprints is selected again, the latest information will be enrolled and any previous information over-written.
 4. The **Fingerprint Enrollment** screen will be displayed and the tutorial will begin. First click "Replay video" and confirm the proper movement for the finger you wish to register. Then confirm the message displayed on this screen and ensure that there is a check mark in the **Run Interactive Tutorial** box. Once this has been done, click **Next**.
 5. At the **Scanning Practice** screen, you are able to practice swiping (three times) your finger to ensure you use the correct method. Click "Try again" to if you wish to practice again. You have finished practicing, click **Next** button.
 6. Register your fingerprint on the **Fingerprint Image Capture** screen. Let the computer read the finger to be registered 3 times. An image of your fingerprint will be shown on the screen each time the fingerprint is successfully read.
Once the fingerprint is successfully read for the third time, the message **Successfully combined** will be displayed beneath the fingerprint images and will close the window automatically.
 7. When the **Store To Sensor** screen is displayed, check **Store fingerprint to Sensor**. Click **Finish** to complete fingerprint registration.



It is strongly recommended that you register 2 or more fingerprints. Repeat the procedure from step 3 to register another fingerprint.

How to Delete the Fingerprint Data

Saved fingerprint data is stored in special non-volatile memory inside the fingerprint sensor. Therefore, if you give the computer to someone else, or dispose of it in any way, the following process is recommended to delete your fingerprint information:

1. To run this program, click **Start -> All Programs -> TrueSuite Access Manager -> TrueSuite Access Manager**.
2. The Verify screen will be displayed. Swipe your registered finger to User's Fingers.
3. The **User's Fingers** screen is displayed.
 - To delete all registered fingerprints
 1. Click **Delete All Fingerprints**.
 2. The user selection screen will be displayed, select which user's fingerprint data to delete and click Ok.
 - Selecting "Delete current user's fingerprints" will delete the fingerprint data for the currently logged in user.
 - Selecting "Delete all users' fingerprints" will delete the fingerprint data for all users, however this item can only be selected if the currently logged in user has administrator privileges.
 3. "Are you sure you want to delete this fingerprint?" will be displayed on the screen, click **Yes** button.
 - To delete individual fingerprints.
 1. Click the fingerprint mark above the registered finger.
 2. "Are you sure you want to delete this fingerprint?" will be displayed on the screen, click Yes button.

In use, please be aware of the following limitations of the fingerprint sensor:

- A warning message will be displayed when recognition is abnormal or recognition is not successful within a fixed duration.
- The fingerprint sensor compares and analyzes the unique characteristics in a fingerprint. However, there may be instances where certain users are unable to register their fingerprints due to insufficient unique characteristics in their fingerprints.
- The recognition success rate may differ from user to user.
- Toshiba does not guarantee that this fingerprint recognition technology will be error-free.
- Toshiba does not guarantee that the fingerprint sensor will recognize the enrolled user or accurately screen out unauthorized users at all times. Toshiba is not liable for any failure or damage that might arise out of the use of this fingerprint recognition software or utility.

Points to note about the Fingerprint Utility software



You are able to backup saved fingerprint data and information within the PasswordBank by using the Import or Export User Data facility under the fingerprint management software. However, please be aware that any encrypted files cannot be backup within FileSafe using this function - in these instances it is recommended that you backup these files to external media using standard file copy processes.

The Encrypting File System (EFS) is a Windows Vista® feature.

If a file is encrypted using EFS, it cannot be encrypted further using the fingerprint authentication function.

Windows Logon via Fingerprint Authentication

If required, you are also able to use fingerprint authentication in place of the usual Windows logon process using your username and password. This method is especially useful where there are many users using the same computer as it removes the need for actual user selection when the system is started.

Fingerprint Authentication Procedure

1. Start up the computer.
2. At the Windows **Welcome** screen, choose any of the enrolled fingers and swipe the fingerprint on the sensor - if the authentication process is successful, the user will automatically be logged in to Windows.



If the fingerprint authentication process fails you will need to log into Windows using the appropriate username and password. In addition, you should use this manual login process if fingerprint authentication fails for three consecutive tries - a warning message will be displayed when authentication is not normal or is not successful within a fixed duration.

Fingerprint Pre-OS Authentication

General

The fingerprint authentication system can be used to replace the keyboard based password authentication system that is used when the computer is turned on.

If you do not want to use the fingerprint authentication system for password authentication while booting up the computer, instead you prefer using the keyboard entry method, simply press the **BACK SPACE** key when the Fingerprint Pre-OS Authentication screen is displayed.

Using this process will switch the password input screen across to the keyboard based entry screen.



- You must ensure that you use the TOSHIBA Password Utility to register a User Password before using the Fingerprint Pre-OS Authentication and its extended function to allow fingerprints to be used to access the computer when it is turned on.
- If the fingerprint authentication process fails five times, a preset time limit is exceeded, or you press the **BACK SPACE** key, [Password =] will be displayed on the screen and you will have to enter either the User Password or Supervisor Password manually in order to start the computer.
- When swiping your finger, please ensure that you do it slowly and at a constant speed. If you find that this does not improve the authentication rate, you should try to adjust the speed at which the finger is swiped.
- If there are any changes in the environment or settings related to authorization, you will be required to provide authorization information such as a User Password (and, if applicable, the HDD(Hard Disk Drive) password).

How to Enable Fingerprint Pre-OS Authentication Settings

It is necessary to first enroll your fingerprint with the Fingerprint Application prior to enabling and configuring the Fingerprint Pre-OS Authentication System. You should check that your fingerprint is enrolled before configuring the settings (please refer to the Manual for [Fingerprint Registration/Enrollment](#) for further instructions).

1. To run this program, click **Start** -> **All Programs** -> **TrueSuite Access Manager** -> **TrueSuite Access Manager with Admin Privileges**.
2. UserAccountControl screen is displayed, click the Allow button. This setting can only be changed if the currently logged in user has administrator privileges.
3. Swipe a registered finger on the fingerprint sensor.
4. Click the **Setting menu** at the TrueSuiteAccessManager screen.
5. Administrator Setting screen is displayed, check the "Enable Pre-OS Fingerprint Authentication" check box and then click **OK**.
6. Click the **Exit** button at the TrueSuiteAccessManager screen.

Fingerprint Single-Swipe Sign-on Feature

General

This is a feature that allows the user to complete the authentication for both the User/BIOS Password and logging onto Windows using only one fingerprint authentication when booting up. It is necessary to register the User/BIOS Password and Windows Logon Password before using the Fingerprint Power-on Security and this Fingerprint Single Sign-on Feature. Please use the TOSHIBA Password Utility to register your User/BIOS Password. If Windows Logon is not the default for your system, see Manual to register your Windows Logon Password.

Only one fingerprint authentication is required to replace the User/BIOS Password and the Windows Logon Password.

How to Enable Fingerprint Single-Swipe Sign-on Feature

It is necessary to first enroll your fingerprint with the TrueSuite Access Manager prior to enabling and configuring the Fingerprint Single Sign-on feature. You should check that your fingerprint is enrolled before configuring the settings (please refer to the Manual for [Fingerprint Registration/Enrollment](#) for further instructions).

1. To run this program, click **Start -> All Programs -> TrueSuite Access Manager -> TrueSuite Access Manager with Admin Privileges**.
2. UserAccountControl screen is displayed, click the Allow button. This setting can only be changed if the currently logged in user has administrator privileges.
3. Swipe a registered finger on the fingerprint sensor.
4. Click the **Settings** at the TrueSuiteAccessManager screen.
5. Administrator Settings screen is displayed, check the "Enable Pre-OS Fingerprint Authentication" and "Enable Single Sign-On Fingerprint Authentication" check box and then click **OK**.
6. Click the **Exit** button at the TrueSuiteAccessManager screen.

Fingerprint utility limitations

TOSHIBA does not guarantee that the fingerprint utility technology will be completely secure or error-free, or that it will accurately screen out unauthorized users at all times. TOSHIBA is not liable for any failure or damage that might arise out of the use of the fingerprint software.



- *The fingerprint sensor compares and analyzes the unique characteristics in a fingerprint. However, there may be instances where certain users are unable to register their fingerprints due to insufficient unique characteristics in their fingerprints.*
- *The recognition success rate may differ from user to user.*

USB Sleep and Charge function

Your computer can supply USB bus power (DC5V) to the USB port even when the power of the computer is turned OFF. "Power OFF" includes sleep mode, hibernation mode or shutdown state.

This function can only be used for ports that support the USB Sleep and Charge function (hereinafter called "compatible ports").

Compatible ports are USB ports that have the (⚡) symbol icon.

You can use the USB Sleep and Charge function to charge certain USB compatible external devices such as mobile phones or portable digital music players.

However, the USB Sleep and Charge function may not work with certain external devices even if they are compliant with the USB specification. In those cases, turn the power of the computer ON to charge the device.



- *The USB Sleep and Charge function only works for compatible ports. This function is disabled in the default setting. To enable it, you must change [Disabled] to [Enabled] in the HW setup.*
- *When USB Sleep and Charge function is set to [Enabled] in HW Setup, USB bus power (DC5V) will be supplied to compatible ports even when the power of the computer is turned OFF. USB bus power (DC5V) is similarly supplied to the external devices which are connected to the compatible ports. However, some external devices cannot be charged solely by supplying USB bus power (DC5V). As for the specifications of the external devices, please contact the device manufacturer or check the specifications of the external devices thoroughly before use.*
- *Using the USB sleep and charge function to charge external devices will take longer than charging the devices with their own chargers.*
- *If external devices are connected to compatible ports when the AC adaptor is not connected to the computer, the battery of the computer will be depleted even when the power of the computer is turned OFF. As such, we recommend that you connect the AC adaptor to the computer when using the USB sleep and charge function.*
- *External devices connected to the USB bus power (DC5V) function that interfaces with the power ON/OFF of the computer may always be in an operational state.*
- *When there is a current overflow of the external devices connected to the compatible ports, USB bus power (DC5V) supply may be stopped for safety reasons.*



Metal paper clips or hair pins/clips will generate heat if they come into contact with USB ports. Do not allow USB ports to come into contact with metal products, for example when carrying the computer in your bag.

How to enable/disable USB sleep and charge function

You can set enable/disable USB sleep and charge function in HW setup. Please refer to the USB Sleep and Charge function in Chapter7.

Using optical disk drives

The full-size drive provides high-performance execution of CD/DVD-ROM-based programs. You can run either 12 cm (4.72") or 8 cm (3.15") CD/DVDs without an adaptor. A Serial ATA interface controller is used for CD/DVD-ROM operation. When the computer is accessing a CD/DVD-ROM, an indicator on the drive glows.



Use the DVD playback application to view DVD-Video discs.

Loading discs

To load CD/DVD's, follow the steps as listed below and refer to figures 4-4 to 4-6.

1. When the computer's power is on, press the eject button to open the disc tray slightly.

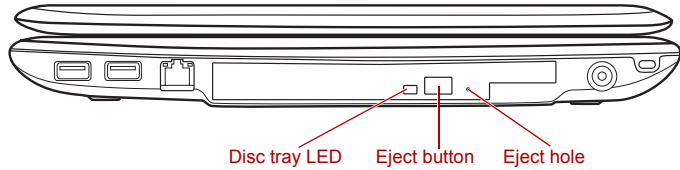

Figure 4-3 Pressing the eject button

2. Grasp the disc tray gently and pull until it is fully opened.

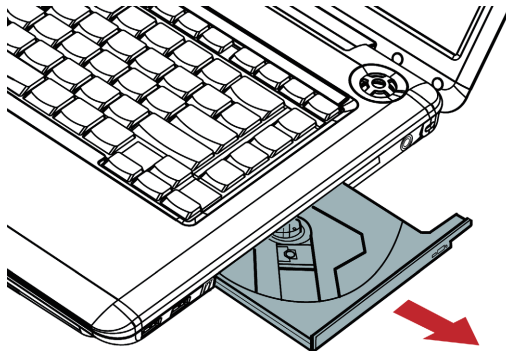

Figure 4-4 Pulling the disc tray open

3. Lay the CD/DVD, label side up, in the disc tray.

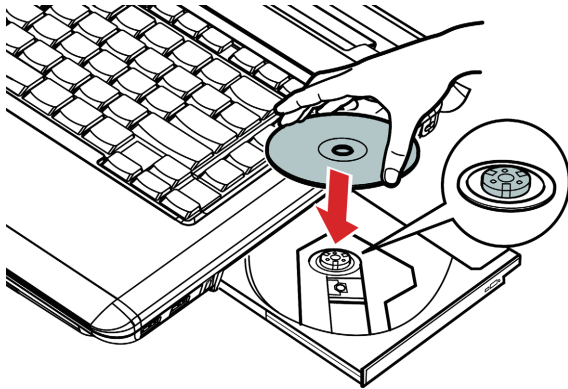

Figure 4-5 Inserting a CD/DVD



When the disc tray is fully opened, the edge of the computer will extend slightly over the area where you insert the media. Therefore, when loading a CD or DVD, you will need to turn it slightly at an angle when you place it in the disc tray. After loading the CD/DVD you should ensure that it is properly positioned over the central spindle and that it lies flat within the tray.



- *Do not touch either the laser lens or the area immediately around it - doing so could cause misalignment and may damage the drive.*
- *Make sure that no foreign objects are inserted into or otherwise enter the drive. Check the disc tray, especially the area behind the front edge, to ensure that there are no foreign objects or material present before closing the drive.*

4. Press the center of the CD/DVD gently until you feel it click into place on the center spindle. The disc should be slightly below the top of the spindle and flush with the spindle base.
5. Press the center of the disc tray in order to close it - the tray will click into place when it is locked.



If the CD/DVD is not seated properly when the disc tray is closed, you may find that the media itself might become damaged, and/or the disc tray might not open fully when you next press the eject button.

Removing discs

To remove CD/DVD's, follow the steps as listed below.



Do not press the eject button while the computer is accessing the media in the drive, instead wait for the indicator to go out before you open the disc tray. In addition, if the CD/DVD media is spinning when you open the tray, wait for it to fully stop before you remove it.

1. When the computer's power is on, press the eject button to open the disc tray slightly and then gently pull it out of the system until it is fully opened.



After the disc tray has opened slightly, you should wait for a moment to ensure the CD/DVD media has stopped spinning before you fully open the tray.

2. The CD/DVD media will extend slightly over the sides of the disc tray in order that you can hold it. Grasp it carefully by its edges and lift it vertically off of the central spindle and out of the tray.

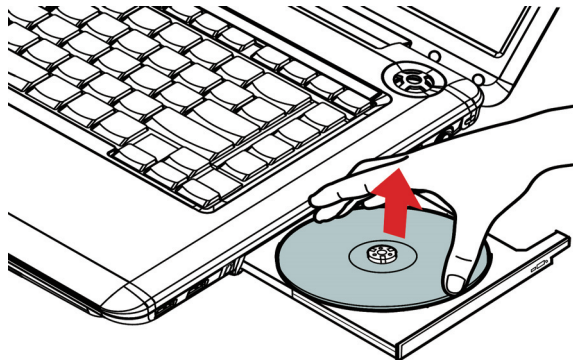

Figure 4-6 Removing a CD/DVD

3. Press the center of the disc tray in order to close it - the tray will click in place when it is locked.

How to remove a CD/DVD when the disc tray will not open

Pressing the eject button will not open the disc tray when the computer is turned off although, in these circumstances, you can open the tray by inserting a slender object such as a straightened paper clip about 15mm into the eject hole just to the right of the drive's eject button.

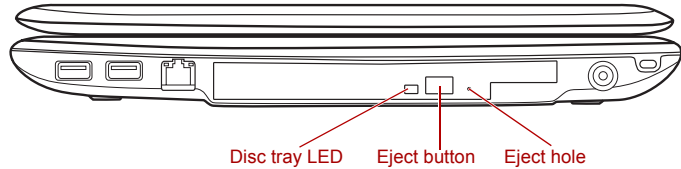

Figure 4-7 Manual release with the eject hole



You must ensure that you turn off the power before you use the eject hole. If the CD/DVD media is spinning when you open the disc tray, it may fly off of the spindle and cause injury.

Function button

This section describes about Function button.

Six buttons are provided with some models.



Figure 4-8 Function button

Icon	Function button	DVD	*CD/None
	Mute	Mute	Mute
	CD/DVD	Launch TOSHIBA DVD PLAYER	Launch Windows Media Player
	Play/Pause	Play/Pause	Play/Pause
	Stop	Stop	Stop
	Previous	Previous chapter	Previous track
	Nexr	Next chapter	Next track

Writing CD/DVD on DVD Super Multi drives



The optical drive installed on this computer cannot write multiple sessions on DVD-R Dual Layer disc sessions. Once a disc has been written to once, it will be finalized. Once finalized, no further writing to the disc will be possible regardless of what portion of the total disc capacity was used.

You can use the DVD-R drive to write data to either CD-R, CD-RW, DVD-R, DVD-R (Dual Layer), DVD-RW, DVD+R, DVD+R (Double Layer), DVD+RW, DVD-RAM, or DVD-R (Dual Layer) discs.

TOSHIBA Disc Creator and Ulead DVD MovieFactory are provided as writing software with this computer.

Ulead DVD MovieFactory can be used to write files in video format.

TOSHIBA Disc Creator can be used to write data.



- Please refer to the [Writable discs](#), Chapter 2 for details about the types of writable CD and DVD discs that can be supported by this computer.
- Do not turn off the power to the optical disc drive while the computer is accessing it as this may cause you to lose data.
- CD-R/RW media cannot be accessed using the Create CD/DVD option in Media Center.
- To write data to CD-R/RW media, use the **TOSHIBA Disc Creator** feature that is installed on your computer.



When writing information to media using an optical drive, you should always ensure that you connect the AC adaptor to a live power socket. It is possible that, if data is written while powered by the battery pack, the write process may sometimes fail due to low battery power - in these instances data loss may occur.

Important message

Before you write or rewrite to any of the media supported by the DVD Super Multi drive, please read and follow all of the setup and operating instructions in this section. If you fail to do so, you may find that the DVD Super Multi drive may not function properly, and you may fail to write or rewrite information successfully - this may cause you to either lose data or incur other damage to the drive or media.

Before writing or rewriting

- Based on TOSHIBA's limited compatibility testing, we suggest the following manufacturers of CD-R, CD-RW, DVD-R, DVD-R (Dual Layer), DVD-RW, DVD+R, DVD+R (Double Layer), DVD+RW or DVD-RAM media, however, it must be noted that disc quality can affect write or rewrite success rates. Please also be aware that in no event does TOSHIBA guarantee the operation, quality or performance of any disc.

CD-R:

TAIYO YUDEN CO., Ltd.
MITSUBISHI KAGAKU MEDIA CO., LTD.
Ricoh Co., Ltd.
Hitachi Maxell, Ltd.

CD-RW: (Multi-Speed and High-Speed)

MITSUBISHI KAGAKU MEDIA CO., LTD.
Ricoh Co., Ltd.

CD-RW: (Ultra-Speed)

MITSUBISHI KAGAKU MEDIA CO., LTD.

DVD-R:

DVD Specifications for Recordable Disc for General Version 2.0
TAIYO YUDEN Co., Ltd. (for 8x and 16x speed media)
MITSUBISHI KAGAKU MEDIA CO., LTD. (for 4x, 8x and 16x speed media)
Hitachi Maxell, Ltd. (for 8x and 16x speed media)

DVD-R (Dual Layer):

MITSUBISHI KAGAKU MEDIA CO., LTD. (for 4x and 8x speed media)

DVD-R for Labelflash:

FUJIFILM CORPORATION (for 16x speed media)

DVD+R:

MITSUBISHI KAGAKU MEDIA CO., LTD. (for 8x and 16x speed media)
Ricoh Co., Ltd. (for 8x and 16x speed media)
TAIYO YUDEN CO., Ltd. (for 8x and 16x speed media)

DVD+R (Double Layer):

MITSUBISHI KAGAKU MEDIA CO., LTD. (for 2.4x and 8x speed media)

DVD+R for Labelflash:

FUJIFILM CORPORATION (for 16x speed media)

DVD-RW:

DVD Specifications for Recordable Disc for Version 1.1 or version 1.2
Victor Company of Japan, Ltd. (JVC) (for 2x, 4x and 6x speed media)
MITSUBISHI KAGAKU MEDIA CO., LTD. (for 2x, 4x and 6x speed media)

DVD+RW:

Ricoh Co., Ltd. (for 2.4x, 4x and 8x speed media)
 MITSUBISHI KAGAKU MEDIA CO., LTD. (for 2.4x, 4x and 8x speed media)

DVD-RAM:**DVD Specifications for DVD-RAM Disc for Version 2.0, Version 2.1 or Version 2.2**

Matsushita Electric Industrial Co.,Ltd. (for 3x and 5x speed media)
 Hitachi Maxell, Ltd. (for 3x and 5x speed media)



- *DVD Super Multi drive cannot use discs that allow writing faster than 16x speed (DVD-R and DVD+R media), 8x speed (DVD-R (Dual Layer), DVD+RW and DVD+R (Double Layer) media), 6x speed (DVD-RW media), 5x speed (DVD-RAM media).*
- *Some types and formats of DVD-R (Dual Layer) and DVD+R (Double Layer) discs may be unreadable.*
- *2.6GB and 5.2GB DVD-RAM media cannot be read from or written to.*
- *DISC created in DVD-R (Dual Layer) format4 (Layer Jump Recording) cannot be read.*
- If the disc is poor in quality, or is dirty or damaged, writing or rewriting errors may be noted - ensure that you check all discs for dirt or damage before you use them.
- The actual number of rewrites to CD-RW, DVD-RW, DVD+RW or DVD-RAM media will be affected by the quality of the disc itself and the way in which it is used.
- There are two types of DVD-R media available, authoring discs and general use discs. Do not attempt to use authoring discs as only general use discs can be written to by a computer drive.
- You can use both DVD-RAM discs that can be removed from a cartridge and DVD-RAM discs designed without a cartridge.
- You may find that other computer DVD-ROM drives or other DVD players may not be able to read DVD-R, DVD-R (Dual Layer), DVD-RW, DVD+R, DVD+R (Double Layer) or DVD+RW discs.
- Data written to a CD-R, DVD-R, DVD-R (Dual Layer), DVD+R or DVD+R (Double Layer) discs cannot be deleted either in whole or in part.
- Data deleted/erased from a CD-RW, DVD-RW, DVD+RW or DVD-RAM disc cannot be recovered. You must check the content of the disc carefully before you delete it, taking care that, if multiple drives that can write data to discs are connected, you do not delete data from the wrong one.
- In writing to DVD-R, DVD-R (Dual Layer), DVD-RW, DVD+R, DVD+R (Double Layer), DVD+RW or DVD-RAM media, some space is required for file management, so you may not be able to write to the full capacity of the disc.

- Since the disc is based on the DVD standard, it might be filled with dummy data if the written data is less than about 1GB. Therefore, in these circumstance, even if you write only a small amount of data, it might take additional time to fill in the dummy data.
- When multiple drives that can write data to discs are connected, be sure that you do not write to or delete data from the wrong drive.
- Be sure to connect the AC adaptor to the computer before you write or rewrite any information.
- Before you enter either Sleep Mode or Hibernation Mode, take care to ensure that any DVD-RAM writing has been completed. In this instance, writing is finished if you can eject the DVD-RAM media.
- Be sure to close all other software programs except for the writing software itself.
- Do not run software such as a screen saver which can put a heavy load on the processor.
- Operate the computer at its full power settings - do not use any power-saving features.
- Do not write information while virus checking software is running, instead wait for it to finish, then disable the virus protection applications, including any software that checks files automatically in the background.
- Do not use any hard disk utilities, including those that are intended to enhance hard disk drive access speeds, as they may cause unstable operation and damage data.
- CD-RW (Ultra Speed +) media should not be used as data may be lost or damaged.
- You should always write from the computer's hard disk drive onto the CD/DVD - do not try to write from shared devices such as a server or any other network device.
- Writing with software other than TOSHIBA Disc Creator has not been confirmed, therefore operation with other software applications cannot be guaranteed.

When writing or rewriting

Please observe the following points while you write or rewrite data to CD-R, CD-RW, DVD-R, DVD-R (Dual Layer), DVD-RW, DVD+R, DVD+R (Double Layer), DVD+RW or DVD-RAM media:

- Always copy data from the hard disk drive to the optical media - do not use the cut-and-paste function as the original data will be lost if there is a write error.
- Do not perform any of the following actions:
 - Change users in the Windows Vista® operating system.
 - Operate the computer for any other function, including such tasks as using a mouse or Touch Pad, or closing/opening the display panel.
 - Start a communication application such as a modem.
 - Apply impact or vibration to the computer.

- Install, remove or connect external devices, including such items as a SD/SDHC memory card, miniSD/microSD Card, ExpressCard, Memory Stick/Memory Stick PRO/Memory Stick PRO Duo, xD picture card, MultiMediaCard, USB device, external monitor, i.LINK device, or an optical digital device.
- Use the audio/video control button to reproduce music or voice.
- Open the optical disc drive.
- Do not use shut down, log off, Sleep Mode or Hibernation Mode functions while writing or rewriting.
- Make sure that the write/rewrite operation is completed before going into either Sleep Mode or Hibernation Mode (writing is completed if you can remove an optical media on the DVD Super Multi drive).
- If the media is of poor quality, or is dirty or damaged, writing or rewriting errors may occur.
- Set the computer on a level surface and avoid places subject to vibration such as airplanes, trains or cars. In addition, do not use the computer on an unstable surface such as a stand.
- Keep mobile phones and other wireless communication devices away from the computer.

Disclaimer

TOSHIBA does not bear responsibility for the following:

- Damage to any CD-R, CD-RW, DVD-R, DVD-R (Dual Layer), DVD-RW, DVD+R, DVD+R (Double Layer), DVD+RW or DVD-RAM disc that may be caused by writing or rewriting with this product.
- Any change or loss of the recorded contents of CD-R, CD-RW, DVD-R, DVD-R (Dual Layer), DVD-RW, DVD+R, DVD+R (Double Layer), DVD+RW or DVD-RAM media that may be caused by writing or rewriting with this product, or for any business profit loss or business interruption that may be caused by the change or loss of the recorded contents.
- Damage that may be caused by using third party equipment or software.

Given the technological limitations of current optical disc writing drives, you may experience unexpected writing or rewriting errors due to disc quality or problems with hardware devices. In view of this, it is good practice to make two or more copies of important data, in case of any undesired change or loss of the recorded contents.

TOSHIBA Disc Creator

Please be aware of the following limitations when you use the TOSHIBA Disc Creator:

- DVD Video cannot be created using TOSHIBA Disc Creator.
- DVD Audio cannot be created using TOSHIBA Disc Creator.

- You cannot use TOSHIBA Disc Creator's 'Audio CD for Car or Home CD Player' function to record music to DVD-R, DVD-R (Dual Layer), DVD-RW, DVD+R, DVD+R (Double Layer) or DVD+RW media.
- Do not use the 'Disc Backup' function of TOSHIBA Disc Creator in order to copy DVD Video or DVD-ROM material that has copyright protection.
- DVD-RAM discs cannot be backed up using the 'Disc Backup' function of TOSHIBA Disc Creator.
- You cannot back up CD-ROM, CD-R or CD-RW media to DVD-R, DVD-R (Dual Layer) or DVD-RW media using the 'Disc Backup' function of TOSHIBA Disc Creator.
- You cannot back up CD-ROM, CD-R or CD-RW media to DVD+R, DVD+R (Double Layer) or DVD+RW media using the 'Disc Backup' function of TOSHIBA Disc Creator.
- You cannot back up DVD-ROM, DVD Video, DVD-R, DVD-R (Dual Layer), DVD-RW, DVD+R, DVD+R (Double Layer) or DVD+RW to CD-R or CD-RW media using the 'Disc Backup' function of TOSHIBA Disc Creator.
- TOSHIBA Disc Creator cannot record in packet format.
- You might not be able to use the 'Disc Backup' function of TOSHIBA Disc Creator to back up a DVD-R, DVD-R (Dual Layer), DVD-RW, DVD+R, DVD+R (Double Layer) or DVD+RW disc that was made with other software on a different optical media recorder.
- If you add data to a DVD-R, DVD-R (Dual Layer), DVD+R or DVD+R (Double Layer) disc that you have already recorded to, you might not be able to read the added data under some circumstances. For example, it cannot be read under 16-bit operating systems, such as Windows 98SE and Windows Me, while in Windows NT4 you will need Service Pack 6 or later, and in Windows 2000, you will need Service Pack 2. In addition to this, some DVD-ROM and DVD-ROM / CD-R/RW drives cannot read this added data regardless of the operating system.
- TOSHIBA Disc Creator does not support recording to DVD-RAM discs - to achieve this you should use Windows Explorer or another similar utility.
- When you back up a DVD disc, be sure that the source drive supports recording to DVD-R, DVD-R (Dual Layer), DVD-RW, DVD+R, DVD+R (Double Layer) or DVD+RW media - if this is not the case then the source disc might not be backed up correctly.
- When you back up a DVD-R, DVD-R (Dual Layer), DVD-RW, DVD+R, DVD+R (Double Layer) or DVD+RW disc, be sure to use the same type of disc.
- You cannot partially delete any data written to a CD-RW, DVD-RW or DVD+RW disc.

Data Verification

To verify that data has been written or rewritten correctly to a data CD/DVD you should follow the steps below before you begin the write/rewrite process:

1. Select Settings for **Each Mode** -> **Data Disc** in the Setting menu.
2. Display the setting dialog box by one of the following two steps:
 - Click the **Recording settings** button () for writing on the main toolbar in the **Data Disc** mode.
 - Select **Setting for Each Mode** -> **Data Disc** in the **Setting** menu.
3. Mark the **Verify written data** check box.
4. Select **File Open** or **Full Compare** mode.
5. Click the **OK** button.

How to learn more about TOSHIBA Disc Creator

Please refer to the Help files for additional TOSHIBA Disc Creator information.

- Opening the TOSHIBA Disc Creator Manua
IStart -> **All Programs** -> **TOSHIBA** -> **CD&DVD Applications** -> **Disc Creator Help**

When Using Ulead DVD MovieFactory® for TOSHIBA

How to make a Labelflash DVD

Simplified steps for making a Labelflash DVD:

1. Insert a Labelflash disc in optical disc drive.



Set **PRINTING SIDE** for underside.

2. Click **Start** -> **All Programs** -> **DVD MovieFactory for TOSHIBA** -> **Ulead DVD MovieFactory for TOSHIBA Lancher** to launch DVD MovieFactory.
3. Click **Print Disc Label** -> **Label Printing. Ulead Label@Once** is started.
4. Click the **General** tab.
5. Choose **optical disc drive for Printer**. e.g.<E:>
6. Add and customize the look of your images and text.
7. Click **Labelflash setting** and choose **Draw Quality**.
8. Click Print.

How to make a DVD-Video

Method 1: Simplified steps for making a DVD-Video from video data captured from a DV-Camcorder:

1. Click **Start** -> **All Programs** -> **DVD MovieFactory for TOSHIBA** -> **Ulead DVD MovieFactory for TOSHIBA Launcher** to launch DVD MovieFactory.
2. Insert a DVD-RW or DVD+RW disc in Burner.
3. Click **Video Disc** -> **Burn Video to Disc** to launch **Direct Recording** dialog box, choose **DVD-Video/+VR** to invoke **Straight Capture to Disc** Page.
4. Choose **DVD-Video** format.
5. Choose the capture source is **DV**.
6. Press **Capture** button.

Method 2: Simplified steps for making a DVD-Video from adding video source:

1. Click **Start** -> **All Programs** -> **DVD MovieFactory for TOSHIBA** -> **Ulead DVD MovieFactory for TOSHIBA Launcher** to launch DVD MovieFactory.
2. Click **Video Disc** -> **New Project** to invoke 2nd Launcher, choose your project type, then invoke DVD MovieFactory.
3. Add source from HD Disk by click **Add Video files** button to invoke browser dialog box.
4. Choose the source video then go to Next page to apply Menu.
5. After choose the menu template, press **Next** button to go to **Burning Page**.
6. Choose the output type then press **Burn** button.

How to learn more about Ulead DVD MovieFactory®

Please refer to the Help and Manual files for additional Ulead DVD MovieFactory information.

Opening the Ulead DVD MovieFactory Manual **Start** -> **All Programs** -> **DVD MovieFactory for TOSHIBA** -> **User Manual** -> **DVD MovieFactory User Manual**

Important information for use

Note the following limitations when you write Video DVD:

1. Editing digital video
 - Log in with Administrator rights to use DVD MovieFactory.
 - Make sure that your computer is running on AC power when using DVD MovieFactory.
 - Operate the computer at Full Power. Do not use power-saving features.
 - While you are editing DVD, you can display preview. However, if another application is running. The preview might not display properly.
 - DVD MovieFactory cannot edit or play copy protected content.
 - Do not enter Sleep or Hibernation Mode while using DVD MovieFactory.
 - Do not operate DVD MovieFactory immediately after turning on the computer. Please wait until all Disc Drive activity has stopped.
 - When recording to a DV-Camcorder, to ensure you capture all of your data, let the camcorder record for a few seconds before you begin recording your actual data.
 - CD recorder, JPEG functions, DVD-Audio, mini DVD and Video CD functions are not supported in this version.
 - While recording video to DVD, please close all other programs.
 - Do not run software like a screen saver because it can put a heavy load on the CPU.
 - Do not support mp3 decode and encode.
2. Before recording the video to DVD
 - When you record DVD disc, please use only discs recommended by the Drive manufacturer.
 - Do not set the working drive to a slow device like a USB1.1 hard disk drive or it will fail to write DVD.
 - Do not perform any of the following actions:
 - Operate the computer for any other function, including using a mouse or Touch Pad, or closing/opening the display panel.
 - Bump or cause vibration to the computer.
 - Use the Mode control button and Audio/Video control button to reproduce music or voice.
 - Open the DVD drive.
 - Install, remove or connect external devices, including the following: SD/SDHC memory card, USB device, external display, i.LINK devices, optical digital devices.
 - Please verify your disc after recording important data.
 - DVD-R/+R/+RW disc cannot be written in VR format.
 - Not support to output VCD and SVCD format.

3. About Straight to Disc
 - Not support to record on DVD-R/+R disc
 - Not support to record DVD+VR format by HDV
 - HDV support to burn DVD-Video only
 - DVD-VR format not support to add Menu
4. About recorded DVDs
 - Some DVD-ROM drives for personal computers or other DVD players may not be able to read DVD-R/+R/-RW/-RAM discs.
 - If you use an over-used rewritable disc, the full formatting might be locked. Please use a brand new disc.

TOSHIBA DVD Player

Please be aware of the following limitations when you use the TOSHIBA DVD PLAYER:

Notes on use

- Frame dropping, audio skipping or out of synch audio and video may occur during playback of some DVD Video titles.
- Close all other applications when using the "TOSHIBA DVD PLAYER". Do not open any other applications or carry out any other operations during DVD Video playback. Playback may stop or not function properly in some situations.
- Unfinalized DVDs created on home DVD recorders may not be playable on the computer.
- Use DVD-Video discs with a region code which is either "the same as the factory default setting" or "ALL".
- Do not playback DVD discs Video while watching or recording television programs using other applications. Doing so may cause DVD Video playback or television program recording errors. In addition, if prescheduled recording starts during DVD Video playback it may cause DVD Video playback or television program recording errors. Please view DVD Video during times when there is no recording prescheduled.
- The resume function cannot be used with some discs on the "TOSHIBA DVD PLAYER".
- It is recommended the AC adaptor be connected when playing DVDVideo. Power saving features may interfere with smooth playback. When playing DVD-Video using battery power, set the Power Options to "High performance".
- Screen savers will not display while playing a movie in the "TOSHIBA DVD PLAYER". The computer will also not go into Sleep Mode, Hibernation Mode or shutdown while using "TOSHIBA DVD PLAYER".
- Do not configure the Display automatic power off function to run while the "TOSHIBA DVD PLAYER" is running.
- Do not switch to Hibernation or Sleep Mode when running the "TOSHIBA DVD PLAYER".

- Do not lock the computer using the **Windows logo** () + **L** keys or the **Fn + F1** keys when running the "TOSHIBA DVD PLAYER".

Display Devices & Audio

1. "TOSHIBA DVD PLAYER" will only run when "Colors" is set to "Highest (32 bit)". The "Colors" setting can be adjusted on the "Monitor" tab in the "Display Settings". To open the Display Settings, click **Start** -> **Control Panel** -> **Appearance and Personalization** -> **Personalization** -> **Display Settings**.
2. If the DVD Video image is not displayed on an external display or television, stop the "TOSHIBA DVD PLAYER", and change the screen resolution in "Resolution" on the "Monitor" tab in the "Display Settings". However, video cannot be output to some external displays and televisions due to output or playback conditions.
3. When viewing DVD-Video on an external display or TV, change the display device before playing. DVD-Video cannot be displayed simultaneously (in clone mode) on both the computer's display panel and an external display.
4. Do not change the screen resolution while running the "TOSHIBA DVD PLAYER".

TOSHIBA DVD PLAYER

1. "TOSHIBA DVD PLAYER" software is supported for playback of DVD-Video and DVD-VR.
2. The "TOSHIBA DVD PLAYER" does not have a parental control function.
3. In order to protect copyrights, the Windows Print Screen function is disabled when "TOSHIBA DVD PLAYER" is running.
4. (Print Screen functions are disabled even when running other applications besides "TOSHIBA DVD PLAYER" and when "TOSHIBA DVD PLAYER" is minimized.) Please close the "TOSHIBA DVD PLAYER" to use the Print Screen function.
5. Carry out the installation/uninstallation of the "TOSHIBA DVD PLAYER" under a user account with administrator rights.
6. Do not change Windows Users while "TOSHIBA DVD PLAYER" is running.
7. For some DVD Video discs, using the control window to change the audio track will also change the subtitle track.

Starting TOSHIBA DVD PLAYER

Use the following procedure to start "TOSHIBA DVD PLAYER".

1. Insert an DVD-Video in the DVD Super Multi drive while Windows Vista® is running. When an DVD-Video disc is set in the DVD drive, the following application selection screen may appear. If this occurs, select Play DVD movie, then click OK to launch the TOSHIBA DVD PLAYER.

2. Touch the CD/DVD panel on the Front operation panel. Or select **Start** -> **All Programs** -> **TOSHIBA DVD PLAYER** to start "TOSHIBA DVD PLAYER".

Operating TOSHIBA DVD PLAYER

Notes on Using "TOSHIBA DVD PLAYER".

1. Screen display and available features may vary amongst DVD-Videos and scenes.
2. Only operation buttons (including remote controller and Front operation panels) which correspond to currently available and active features will be useable during DVD playback.
3. If the menu is opened in the Display Area using the Control window's Top Menu or Menu buttons, touch pad and mouse menu operations may not be able to be used.

Open TOSHIBA DVD PLAYER HELP

TOSHIBA DVD PLAYER features and instructions are also explained in detail in "TOSHIBA DVD PLAYER Help". Use the following procedure to open "TOSHIBA DVD PLAYER Help".

- Click the "Help" button () in the Display Area.

Media care

This section provides tips on protecting data stored on your CD's, DVD's and floppy diskettes. Handle your media with care. Following the simple precautions listed below will increase the lifetime of your media and protect the data stored on it.

CD/DVDs

1. Store your CD's and DVD's in the containers they originally came in to protect them and keep them clean.
2. Do not bend the CD's or DVD's.
3. Do not write on, apply a sticker to, or otherwise mar the surface of the CD or DVD that contains the data.
4. Hold the CD or DVD by its outside edge or the edge on the center hole - any fingerprints on the surface of the disc can prevent the drive from properly reading data.
5. Do not expose the CD or DVD to direct sunlight, extreme heat or cold.
6. Do not place heavy objects on your CD's or DVD's.
7. If your CD's or DVD's become dusty or dirty, wipe them with a clean dry cloth from the center hole outwards - do not wipe in a circular direction. If necessary, you can use a cloth that has been lightly dampened in water or a neutral cleaner but you must not use benzine, thinner or any similar cleaning solution.

Floppy diskettes



The USB floppy diskette drive is available only as an option.

1. Store your floppy diskettes in the container they came in to protect them and keep them clean. If a floppy diskette becomes dirty, clean it with a soft, lightly dampened cloth - do not use cleaning fluid.
2. Never open the shutter or touch the magnetic surface of your floppy diskette - doing this could permanently damage it and lose data.
3. Always handle floppy diskettes with care to prevent the loss of stored data.
4. Always apply the floppy diskette label in the correct location and never apply a new label on top of an existing one - in this instance the label could come loose and damage the floppy diskette drive.
5. Never use a pencil for writing on a floppy diskette label as the dust from the pencil lead could cause a system malfunction if it found its way onto the computer's components. In this instance, always use a felt-tipped pen and write the label first before applying it to the floppy diskette.
6. Never put a floppy diskette in a location where water or other liquid may make contact with it, or where it is excessively damp - either of these conditions could cause data loss.
7. Never use a wet or damp floppy diskette - this could damage the floppy diskette drive or other devices within the computer.
8. Data may be lost if the floppy diskette is twisted, bent, or exposed to direct sunlight, extreme heat or cold.
9. Do not place heavy objects on your floppy diskettes.
10. Do not eat, smoke, or use items such as erasers near your floppy diskettes as foreign particles inside the jacket of the floppy diskette can damage the magnetic surface.
11. Magnetic energy can destroy the data on your floppy diskettes. In view of this you should keep your floppy diskettes away from speakers, radios, televisions and other sources of magnetic fields.

Sound system

This section describes some of the audio control functions.

Adjusting System Volume

You can control the overall level of sound using Windows **Volume Mixer**.

To launch Volume Mixer, follow the steps below.

1. Locate the **Speaker** icon on the task tray.
2. Right-click the **Speaker** icon on the task tray.
3. Select **Open Volume Mixer** from the menu.

Click the **Device** button to display available playback devices. Select **Speakers** to use the internal speakers for listening. Adjust speaker volume by moving the slider up or down to raise or lower the volume. Click the

Mute button  to mute the sound.

You may see another control under **Applications** in **Volume Mixer**. It is the control for an application which is currently running. The **Windows Sounds** is always displayed since it controls the system sounds' volume.

Changing System Sounds

System sounds are assigned to inform you when certain events happen. This section explains how to select an existing scheme or save one you have modified.

To launch the configuration dialog window for system sounds, follow the steps below.

1. Right-click the **Speaker** icon on the task tray.
2. Select **Sounds** from the menu.

Realtek HD Audio Manager

You can confirm and change the audio configuration using the **Realtek Audio Manager**. To launch the **Realtek Audio Manager**, click **Start -> Control Panel -> Hardware and Sound -> Realtek HD Audio Manager**.

When you first launch the Realtek Audio Manager, you will see following device tabs. **Speakers** is the default output device. **Microphone** is the default input device. To change the default device, click the **Set Default Device** button under the chosen device tab.

- **Speakers** is the default output device. Select it when using the internal speakers or headphones.
- **Digital Output** should be selected when connecting the optical cable to the Headphone (S/PDIF) jack for playing digital sound on digital audio equipment. Digital Output can only be used by connecting an optical audio cable.
- **HDMI Output** should be selected when connecting the HDMI cable to the HDMI jack for playing digital sound on digital audio equipment.
- **Microphone** is the default input device. It should be selected when using the computer's internal microphone or an external microphone connected to the Microphone jack to record sound.

If an external microphone or audio cable is connected to the Microphone jack, the Realtek HD Audio Manager Connector Settings dialog will be displayed allowing selection of either "Line In" or "Mic In" input.

Information

Click the **information** button  to view hardware information, software information, and language setting.

Speaker Configuration

Click the **playback button**  to confirm the internal speakers or the headphone sound is coming from the right direction.

Sound Effects

This section explains how to select various sound effects.

- **Environment** - simulates reverberations of sound for familiar environments around us. You can select an existing preset in the menu.
- **Equalizer** - raises or lowers a frequency of sound to simulate a popular genre of music. You can select an existing preset in the menu.
- **Karaoke** - cancels the specific frequency of sound and results in the **Vocal Cancellation**. Clicking the **Karaoke** icon, lowers the vocal sound within music. Using the arrow buttons will adjust the musical key of the sound.

Microphone Effects

Microphone Effects are only found within **Microphone** window.

- **Noise Suppression** reduces background noise and fan noise.
- **Acoustic Echo Cancellation** reduces feedback and feedback echo.

Default Format

You can change the sample rate and bit depth of sound.

Dolby Sound Room®

Dolby Sound Room provides stunning personal surround sound from any pair of speakers or headphones. Ideal when using surround sound speakers is not practical, Dolby Sound Room enables an enveloping entertainment experience.

Dolby Sound Room technologies:

- **Dolby Headphone** - Personal surround sound using any set of headphones so that listeners feel like the action is happening all around them.
- **Sound Space Expander** - Widens the sound experience to "wrap" around the listener.
- **Natural Bass** - Extends the bass response of any speakers by up to an octave.

To open the user interface of Dolby Sound Room, steps as detailed below:

1. Click the right button of a mouse on the speaker icon on the Windows Taskbar, and select **Playback Devices** in the sub menu.
2. On the **Playback** tab, select **Speakers**, and click **Properties**.
3. Click the **Dolby** tab.

Using the web camera

Some models are equipped with a Web Camera.

Web Camera is a device that allows you to record video or take photographs with your computer. You can use it for video chatting or video conferences using a communication tool such as **Windows Live Messenger**. **Camera Assistant Software** will help you to add various video effects to your video or photograph.

Enables the transmission of video and use of video chat via the internet using specialized applications.

The effective pixel count for this web camera is 1.3 million and 0.3million (0.3M maximum photograph size: 640X480 pixels; 1.3M maximum photograph size: 1280X1024 pixels).

Please refer to the Camera Assistant Software Online Help for details.

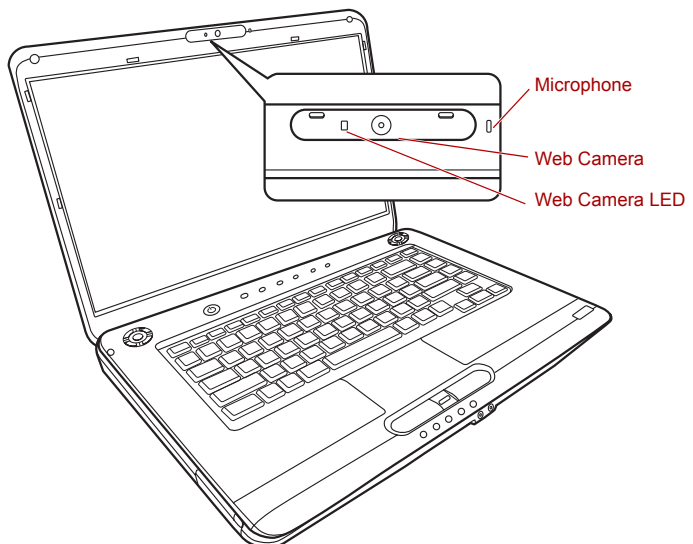

Figure 4-9 Web Camera



- Please unstick the protective plastic-film before using the Web Camera.
- Do not point the web camera directly at the sun.
- Do not touch or press strongly on the web camera lens. Doing so may reduce image quality. Use an eyeglass cleaner (cleaner cloth) or other soft cloth to clean the lens if it becomes dirty.
- Setting the [Size] to more than "800x600" will cause a larger amount of data to be written to the hard disk drive and may interfere with smooth recording.

Using TOSHIBA Face Recognition

This feature uses a face verification library to verify the face data of users when they log in Windows. The user can thus avoid having to enter a password or the like, which makes the login process easier.



- *TOSHIBA Face Recognition does not guarantee the correct identification of a user. Changes to the likeness of a registrant, such as hairstyle changes, wearing a cap, or wearing glasses may affect the recognition rates when such changes occur after the registrant had registered.*
- *TOSHIBA Face Recognition may incorrectly recognize faces that are similar to a registrant.*
- *For high security purposes, TOSHIBA Face Recognition is not a suitable substitute for Windows passwords. When security is a high priority, use your established Windows passwords to log in.*
- *Bright background light and/or shadows may prevent a registrant from being recognized correctly. In that case, log in using your Windows password. If recognition of a registrant fails repeatedly, refer to your computer documentation to learn ways to improve recognition performance.*
- *TOSHIBA Face Recognition records face data in a log when face recognition fails. When transferring ownership or disposing of your computer, please uninstall the application or delete all the logs created by the application. For details on how to do this, see help file.*

Disclaimer

Toshiba does not guarantee that the face recognition utility technology will be completely secure or error-free. Toshiba does not guarantee that the face recognition utility will accurately screen out unauthorized users at all times. Toshiba is not liable for any failure or damage that might arise out of the use of the face recognition software or utility.

TOSHIBA, ITS AFFILIATES AND SUPPLIERS SHALL HAVE NO RESPONSIBILITY FOR DAMAGE TO OR LOSS OF ANY BUSINESS, PROFITS, PROGRAMS DATA, NETWORK SYSTEMS OR REMOVABLE STORAGE MEDIA ARISING OUT OF OR RESULTING FROM THE USE OF THE PRODUCT, EVEN IF ADVISED OF THE POSSIBILITY THEREOF.

How to register the Face Recognition Data

Take a picture for facial verification purposes, and register the data needed when you log in. To register the data needed when you log in, follow the steps as described below:

1. To launch this utility, click **Start -> All Programs -> TOSHIBA -> Utilities -> TOSHIBA Face Recognition**.



- *The **Registration** screen is displayed for a logged-in user whose face has not been registered.*
- *The **Management** screen is displayed for a logged-in user whose face has already been registered.*

2. Click the **Register face** button in the **Management** screen. The **Registration** screen is displayed.



- *If you wish to practice, click on the **Next** button in the **Registration** screen.*
- *If you do not wish to practice, click on the **Skip** button in the **Registration** screen.*

3. Click the **Next** button to start the guide.
4. First, take a picture while moving your neck slightly to the left and right.
5. Now take a picture while moving your neck down and up. Or click the **Back** button to practice the guide once more.
6. Click the **Next** button to start image-capturing process.
Adjust the position of your face so that it fits within the face-shaped frame.
7. Once your face has been positioned properly, the recording will commence.
Start moving your neck very slightly to the left and right, and then move your neck down and up.
8. Registration will end after you have repeatedly moved your neck left, right, down and up.
When the register succeeds, below message will be displayed on the screen: "**Registration successful. Now we'll do the verification test. Click the Next button.**"
Click the Next button to perform the verification test.
9. Perform the verification test. Face the screen as you do when you register.



- *If verification fails, click the **Back** button and re-register. Please refer to step 8 from step 6.*

10. If verification is successful, click the **Next** button and register an account.
11. Register the account. Fill in the account registration fields. Fill in the all fields.

- The **Management** screen is displayed.

The registered account name will be displayed. Clicking on it will cause the captured image of your face to be displayed on the left.

How to Delete the Face Recognition Data

Delete image data, account information, and personal record data created during registration. To delete the Face Recognition Data, follow the steps as described below:

- To launch this utility, click **Start -> All Programs -> TOSHIBA -> Utilities -> TOSHIBA Face Recognition**.
The **Management** screen is displayed.
- Select a user which is deleted in the **Management** screen.
- Click the **Delete** button. "**You are about to delete the user data. Would you like to continue?**" will be displayed on the screen.
 - If you do not want the data to be deleted, click the **No** button and you will then be returned to the **Management** screen.
 - Clicking on the **Yes** button will remove the selected user from the **Management** screen.

How to launch the help file

For further information on this utility, please refer to the help file.

- To launch the help file, click **Start -> All Programs -> TOSHIBA -> Utilities -> TOSHIBA Face Recognition Help**.

Windows Logon via TOSHIBA Face Recognition

This section explains how to login to Windows with TOSHIBA Face Recognition. Two authentication modes are provided.

- **AUTO Mode Login screen:** If the face authentication tile is selected by default, you can log in without using the keyboard or mouse.
- **1:1 Mode Login screen:** This mode is essentially the same as AUTO mode, but the **Select Account** screen will appear before the **Display Captured Image** screen, and you will need to select the user account to be authenticated in order to start the authentication process.

AUTO Mode Login screen

- Turn on the computer.
- The **Select Tiles** screen will be displayed.
- Select Start face recognition ().
- "**Please turn your face to the camera**" will be displayed.
- Verification will be performed. If the authentication is successful, the image data taken in step 4 will be faded in and placed over one another.



- *If an error occurs during authentication, you will be returned to the **Select Tiles** screen.*

6. **Windows Welcome** screen will be displayed, and will be logged in automatically to Windows.

1:1 Mode Login screen

1. Turn on the computer.
2. The **Select Tiles** screen will be displayed.
3. Select Start face recognition ()
4. The **Select Account** screen will be displayed.
5. Select the account, and click the **Arrow** button.
6. **"Please turn your face to the camera"** will be displayed.
7. Verification will be performed. If the authentication is successful, the image data taken in step 6 will be faded in and placed over one another.



- *If an error occurs during authentication, you will be returned to the **Select Tiles** screen.*

8. **Windows Welcome** screen will be displayed, and will be logged in automatically to Windows.



- *If authentication was successful, but an authentication error subsequently occurred during the login to Windows, you will be asked to provide your account information.*

Modem

This section describes how to connect and disconnect the internal modem to and from a telephone jack.



- *Connection to any communication line other than an analog phone line could cause a computer system failure.*
 - *Connect the built-in modem only to ordinary analog phone lines.*
 - *Never connect the built-in modem to a digital line (ISDN).*
 - *Never connect the built-in modem to the digital connector on a public telephone or to a digital private branch exchange (PBX).*
 - *Never connect the built-in modem to a key telephone system for residences or offices.*
- *Avoid using your computer modem with the telephone cable connected during an electrical storm. There may be a remote risk of electric shock from lightning.*



- *Modem functions cannot be used in models which are not equipped with a modem.*
- *This information is applicable to the models equipped with a built-in modem.*
- *Some models are equipped with a modem jack or FM antenna port.*

Region selection

Telecommunication regulations vary from one region to another, so you will need to make sure the internal modem's settings are correct for the region in which it will be used.



The built-in modem can be used only in specified countries and regions. Using the modem in an area not specified for use may cause a system failure. Check the specified areas carefully before using it.

To select a region, follow the steps as detailed below:

1. Click **Start** -> **All Programs** -> **TOSHIBA** -> **Networking** -> **Modem Region Select**.



If it is available, do not use the Country/Region Select function included as part of the modem setup utility within the Control Panel - if you change the country/region setting this way you may find that the change does not take effect.

2. The Region Selection icon will appear in the Windows Taskbar.
3. Click the icon with the primary (left) mouse button to display a list of regions that the modem supports, together with a sub-menu which details telephony location information - a check mark will appear next to the currently selected region and telephony location.
4. Select either a region from the region menu or a telephony location from the sub-menu.
 - When you click a region it becomes the modem's default selection for any new dialling locations that are created within the Windows Control Panel (Phone and Modem Options).
 - When you select a telephony location, the corresponding region is automatically selected and becomes the modem's default setting.

Properties menu

Click the icon with the secondary (right) mouse button in order to display a Properties menu on the screen.

Setting

Within the Properties menu you are able to either enable or disable the following settings:

AutoRun Mode

Allows you to configure whether the Modem Region Select utility starts automatically whenever you start up the operating system.

Open the Dialing Properties dialog box after selecting region

Allows you to configure whether the dialing properties dialog box will be displayed automatically after you have selected a region.

Location list for region selection

Displays a sub-menu appears which details location information.

Open dialog box, if the modem and Telephony Current Location region code do not match

Displays a warning if the current settings for both region code and telephony location are different.

Modem Selection

If the computer cannot recognize the internal modem, a dialog box is displayed from which you should select the appropriate communications port for your modem to use.

Dialing Properties

You should select this item in order to display the dialing properties.



If you are using the computer in Japan, the Telecommunications Business Law requires that you select Japan region mode. It is illegal to use the modem in Japan with any other selection.

Connecting the modular cable

To connect the modem's modular cable, follow the steps as detailed below:



- *Connection to any communication line other than an analog phone line could cause a computer system failure.*
- *Connect the built-in modem only to ordinary analog phone lines.*
- *Never connect the built-in modem to a digital line (ISDN).*
- *Never connect the built-in modem to the digital connector on a public telephone or to a digital private branch exchange (PBX).*
- *Never connect the built-in modem to a key telephone system for residences or offices.*
- *Avoid using your computer modem with the telephone cable connected during an electrical storm. There may be a remote risk of electric shock from lightning.*

1. Plug the end of the modular cable into the computer's modem jack.

2. Plug the other end of the modular cable into a telephone jack.

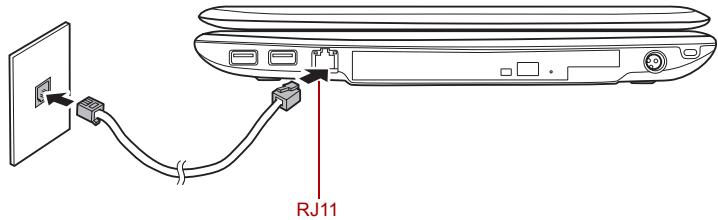

Figure 4-10 Connecting the internal modem



Do not pull on the cable or move the computer while the cable is connected.

Disconnecting the modular cable

To disconnect the modular cable, follow the steps as detailed below:

1. Pinch the lever on the plug in the telephone jack and pull it out from within the connector.
2. Pinch the lever on the plug in the computer's modem jack and pull it out from within the computer.

FM tuner

This section describes how to connect the FM tuner antenna to the computer's FM antenna port.

Use the FM Radio of Windows Media Center to listen to FM radio.



Some models are equipped with a modem jack or FM antenna port.

Using the FM tuner

To connect the FM tuner antenna, follow the steps as detailed below:

1. Plug the FM tuner antenna into the computer's FM tuner jack.



Figure 4-11 Connecting the FM tuner jack

2. Select **Start** -> **All Programs** -> **NXP FM Tuner** to start FM software.

Wireless communications

The computer's wireless communication function supports both Wireless LAN and Bluetooth devices.

All models are provided with Wireless Communication switch. Some models are equipped with both Wireless LAN and Bluetooth functions.

Wireless LAN

The Wireless LAN is compatible with other LAN systems based on Direct Sequence Spread Spectrum/Orthogonal Frequency Division Multiplexing radio technology that complies with the IEEE802.11 Wireless LAN standard.

- Frequency Channel Selection of 5GHz for IEEE 802.11a or n draft 2.0
- Frequency Channel Selection of 2.4GHz for 802.11b/g or n draft 2.0
- Roaming over multiple channels
- Card power management
- Wired Equivalent Privacy (WEP) data encryption based on an 128-bit encryption algorithm
- Wi-Fi Protected Access™ (WPA™) support
- Advanced Encryption Standard (AES) data encryption



The transmission speed over the wireless LAN, and the distance over which the wireless LAN can reach, may vary depending on surrounding electromagnetic environment, obstacles, access point design and configuration, client design and software/hardware configurations. The transmission rate described is the theoretical maximum speed as specified under the appropriate standard - the actual transmission speed will be lower than the theoretical maximum speed.

Setting

1. Please make sure that the **Wireless Communication Switch** is turned on.
2. Click **Start** and then click **Connect To** to display **Connect to a network** window.
3. Click **Set up a connection or network**.
4. Follow the wizard. You will need the name of the wireless network together with security settings. Consult the documentation accompanied with your router or ask your wireless network administrator for the settings.

Security

- TOSHIBA strongly recommend that you enable encryption functionality, otherwise your computer will be open to illegal access by an outsider using a wireless connection. If this occurs, the outsider may illegally access your system, eavesdrop, or cause the loss or destruction of stored data.
- TOSHIBA is not liable for the loss of data due to eavesdropping or illegal access through the wireless LAN and the damage thereof.

Bluetooth wireless technology

Bluetooth™ wireless technology eliminates the need for cables, such as desktop computers, between your PC and other electronic devices, example of printers and mobile phones.

You cannot use the computer's built-in Bluetooth functions and an external Bluetooth adaptor simultaneously.

For reference, Bluetooth wireless technology has the following features:

Worldwide operation

The Bluetooth radio transmitter and receiver operate in the 2.4GHz band, which is license-free and compatible with radio systems in most countries in the world.

Radio links

You can easily establish links between two or more devices, with these links being maintained even if the devices are not within a line-of-sight of each other.

Security

Two advanced security mechanisms ensure a high level of security:

- Authentication prevents access to critical data and makes it impossible to falsify the origin of a message.
- Encryption prevents eavesdropping and maintains link privacy.

Bluetooth™ Stack for Windows® by TOSHIBA

Please note that this software is specifically designed for the following operating systems:

- Microsoft® Windows Vista®

Information regarding the use of this software with these operating systems is listed below, with further details being contained with the electronic help files supplied with the software.



This Bluetooth Stack is based on the Bluetooth Version 1.1/1.2/2.0+EDR/2.1+EDR specification. However, TOSHIBA cannot confirm the compatibility between any computing products and/or other electronic devices that use Bluetooth, other than TOSHIBA notebook computers.

Release Notes related to the Bluetooth® Stack for Windows® by TOSHIBA

1. Fax application software:
Please be aware that there is some fax application software that you cannot use on this Bluetooth™ Stack.
2. Multi-user considerations:
On Windows Vista®, the use of Bluetooth is not supported in a multi-user environment. This means that, when you use Bluetooth, other users that are logged into the same computer will not be able to use this type of functionality.

Product Support:

The latest information regarding operating system support, language support or available upgrades can be found on our web site <http://www.toshiba-europe.com/computers/tnt/bluetooth.htm> in Europe or www.pcsupport.toshiba.com in the United States.

Wireless communication switch

You can enable or disable Wireless communication (Wireless LAN and Bluetooth) function, with the on/off switch. No transmissions are sent or received when the switch is off. Slide the switch to the left to turn it off and to the right to turn it on.

- *Do not use the Wireless LAN (Wi-Fi) or Bluetooth functionalities near a microwave oven or in areas subject to radio interference or magnetic fields. Interference from a microwave oven or other source can disrupt Wi-Fi or Bluetooth operation.*
- *Turn Wi-Fi and Bluetooth functionalities off when near a person who may have a cardiac pacemaker implant or other medical electric device. Radio waves may affect pacemaker or medical device operation, possibly resulting in serious injury. Follow the instruction of your medical device when using any Wi-Fi or Bluetooth functionality.*
- *Always turn off Wi-Fi or Bluetooth functionality if the computer is near automatic control equipment or appliances such as automatic doors or fire detectors. Radio waves can cause malfunction of such equipment, possibly resulting in serious injury.*
- *It may not be possible to make a network connection to a specified network name using the ad hoc network function. If this occurs, the new network(*) will have to be configured for all computers connected to the same network in order to re-enable network connections.*
** Please be sure to use new network name.*

Wireless communication indicator

The wireless communication indicator shows the status of the computer's wireless communication functions.

Indicator status	Indication
Indicator off	The wireless communication switch is off - no wireless functionality is available.
Indicator glows	Wireless communication switch is on. Wireless LAN or Bluetooth is turned on by an application.

If you used the Taskbar to disable the wireless LAN, restart the computer or perform the following procedure to re-enable it: **Start -> Control Panel -> System and Maintenance -> System -> Device Manager -> Network adapters** and right click the wireless device then choose **enable**.

LAN

The computer has built-in support for Ethernet LAN (10 megabits per second, 10BASE-T), Fast Ethernet LAN (100 megabits per second, 100BASE-TX) and Gigabit Ethernet LAN (1000 megabits per second, 1000BASE-T). This section describes how to connect/disconnect to a LAN.



Do not install or remove a memory module while Wake-up on LAN is enabled.



- *The Wake-up on LAN function consumes power even when the system is off. Leave the AC adaptor connected while using this feature.*
- *The Link speed (10/100/1000 megabits per second) changes automatically depending on the network conditions (connected device, cable or noise and so on).*

LAN cable types



The computer must be configured properly before connecting to a LAN. Logging onto a LAN using the computer's default settings could cause a malfunction in LAN operation. Check with your LAN administrator regarding set-up procedures.

If you are using Gigabit Ethernet LAN (1000 megabits per second, 1000BASE-T), be sure to connect with a CAT5E cable or higher. You cannot use a CAT3 or CAT5 cable.

If you are using Fast Ethernet LAN (100 megabits per second, 100BASE-TX), be sure to connect with a CAT5 cable or higher. You cannot use a CAT3 cable.

If you are using Ethernet LAN (10 megabits per second, 10BASE-T), you can connect with a CAT3 or higher cable.

Connecting the LAN cable

To connect the LAN cable, follow the steps as detailed below:



- *Connect the AC adaptor before connecting the LAN cable. The AC adaptor must remain connected during LAN use. If you disconnect the AC Adaptor while the computer is accessing a LAN, the system may hang up.*
- *Do not connect any other cable to the LAN jack except the LAN cable. Otherwise, malfunctions or damage may occur.*
- *Do not connect any power supplying device to the LAN cable that is connected to the LAN jack. Otherwise, malfunctions or damage may occur.*

1. Turn off the power to the computer and to all external devices connected to the computer.
2. Plug one end of the cable into the LAN jack. Press gently until you hear the latch click into place.

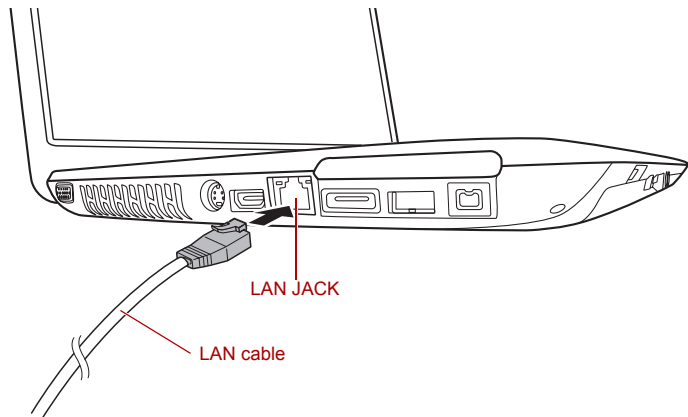

Figure 4-12 Connecting the LAN cable

3. Plug the other end of the cable into a LAN hub connector or router. Check with your LAN administrator and hardware or software vendor before using or configuring a network connection.



*When the computer is exchanging data with the LAN, the **LAN Active** indicator glows yellow. When the computer is connected to a LAN hub but is not exchanging data, the **Link** indicator glows.*

Disconnecting the LAN cable

To disconnect the LAN cable, follow the steps as detailed below:



Make sure the **LAN Active** indicator (amber LED) is out before you disconnect the computer from the LAN.

1. Pinch the lever on the connector in the computer's LAN jack and pull out the connector.
2. Disconnect the cable from the LAN hub or router in the same manner. Check with your LAN administrator and hardware or software vendor before disconnecting from the hub.

Cleaning the computer

To help ensure long, trouble-free operation, keep the computer free of dust and dirt, and use care with all liquids around it.

- Be careful not to spill liquids into the computer. If the computer does get wet, turn the power off immediately and let the computer dry completely - in these circumstance you should get the computer inspected by an authorized service provider in order to assess the scope of any damage.
- Clean the plastics of the computer using a slightly water dampened cloth.
- You can clean the display screen by spraying a small amount of glass cleaner onto a soft, clean cloth and then wiping the screen gently with the cloth.

Using the cleaning cloth

Some models include 1 cleaning cloth.

The cleaning cloth can be used to wipe away dust and fingerprints from the keyboard and palm rest area of your computer.



- *When wiping the keyboard, palm rest and display panel, do so gently without using excessive pressure.*
- *Do not use the cleaning cloth when it is dirty or wet.*
- *Do not use the cleaning cloth soaked with water, detergents or volatile organic solvents.*

It is recommended that you wash the cloth if it gets soiled using a gentle, mild detergent and rinse it well. Allow it to air dry completely before using it again on your computer.



Never spray cleaner directly onto the computer or let liquid run into any part of it. Never use harsh or caustic chemical products to clean the computer.

- *Use the cleaning cloth to wipe away dust, fingerprints and similar from the keyboard, palm rest and other parts. For precautions on use refer to the Using the cleaning cloth section in Chapter4, [Operating Basics](#).*

Moving the computer

While the computer is designed for rugged durability you should exercise a few simple precautions when moving it in order to help ensure trouble-free operation.

- Make sure all disk/disc activity has ended before moving the computer - check that the HDD and other indicators on the front of the computer are off.
- If a CD or DVD is in the drive, remove it and make sure that the disc tray is securely closed.
- Turn off (shut down) the computer.
- Disconnect the AC adaptor and all peripherals before moving the computer.
- Close the display panel.
- Do not pick up the computer by its display panel.
- Before carrying your computer, shut it down, disconnect the AC adaptor and allow it to cool down - a failure to follow this instruction may result in minor heat injury.
- Be careful not to subject the computer to impact or shock - a failure to follow this instruction could result in damage to computer, computer failure or loss of data.
- Never transport your computer with any cards installed - this may cause damage to either the computer and/or the card resulting in product failure.
- Always use a suitable carry case when transporting the computer.
- When carrying your computer, be sure to hold it securely so that it does not fall or hit anything.
- Do not carry your computer by holding any of its protruding elements.

Heat dispersal

To protect from overheating, the CPU has an internal temperature sensor. If the computer's internal temperature rises to a certain level, the cooling fan is turned on or the processing speed is lowered. You can select whether to control the CPU temperature by turning on the fan first, then if necessary, lowering the CPU speed. Or, by lowering the CPU speed first, then if necessary, turning on the fan. These functions are controlled within the Power Options.

When the CPU temperature falls to a normal range, the fan is turned off and the CPU operation returns to standard speed.



If the CPU temperature reaches an unacceptably high level with either setting, the system automatically shuts down to prevent damage. Data in memory will be lost.

Chapter 5

The Keyboard

The computer's keyboard layouts are compatible with a 104/105-key enhanced keyboard - by pressing some keys in combination, all of the 104/105-key enhanced keyboard functions can be performed on the computer.

The number of keys available on your keyboard will depend on which country/region your computer is configured for, with keyboards being available for numerous languages.

In use there are six different types of keys, specifically typewriter keys, function keys, soft keys, Hot keys, Windows special keys and the keypad overlay.

Typewriter keys

The typewriter keys produce the upper-case and lower-case letters, numbers, punctuation marks, and special symbols that appear on the screen. However, there are some differences between using a typewriter and using a computer keyboard:

- Letters and numbers produced in computer text vary in width. Spaces, which are created by a 'space character' may also vary depending on line justification and other factors.
- The lowercase l (el) and the number 1 (one), together with the uppercase O (oh) and the 0 (zero), are not interchangeable on computers as they are on a typewriter.
- The **CAPS LOCK** function key locks only the alphabetic characters into upper-case while the Shift Lock function on a typewriter places all keys in the shifted position.
- The **SHIFT** keys, the **Tab** key, and the **BACK SPACE** key perform the same function as their typewriter counterparts but also have special computer functions.



Never remove the key caps on your keyboard. Doing so could cause damage to the parts under the key caps.

Function keys: F1 ... F12

The function keys (not to be confused with the special **FN** key) are the twelve keys at the top of your keyboard - these keys function differently from other keys.

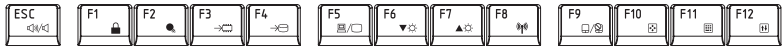

F1 through **F12** are called function keys because they execute programmed functions when pressed and, when used in combination with the **FN** key, those keys marked with icons also execute specific functions on the computer. Please refer to the section, [Soft keys: FN key combinations](#), in this chapter for further information, taking care to note that the function executed by individual keys will depend on the software you are using.

Soft keys: FN key combinations

The **FN** (function) is unique to TOSHIBA computers and is used in combination with other keys to form soft keys. Soft keys are key combinations that enable, disable or configure specific features.



Please note that some software may disable or interfere with soft-key operations, and that the soft-key settings are not restored when the computer returns from Sleep Mode.

Emulating keys on an enhanced keyboard

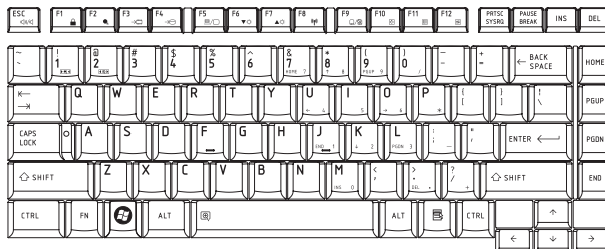
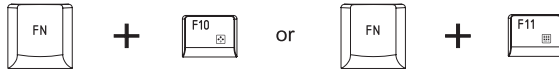

Figure 5-1 A 104-key enhanced keyboard layout

This computer's keyboard is designed to provide all the features of the 104-key enhanced keyboard.

Since the keyboard is smaller and has fewer keys, some of the enhanced keyboard functions must be simulated using two keys instead of one on the larger keyboard.

The **FN** key can be combined with the following keys to simulate functions similar to those of keys on the 104/105 key enhanced keyboard which are not on this computer's keyboard.



Press **FN + F10** or **FN + F11** to access the computer's integrated keypad. When activated, the keys with grey markings on their bottom edge become either numeric keypad keys (**FN + F11**) or cursor control keys (**FN + F10**). Please refer to the [Keypad overlay](#) section in this chapter for more information on how to operate these keys, taking care to note that the power on default for both settings is off.



Press **FN + F12 (ScrLock)** to lock the cursor on a specific line. The power on default is off.



Press **FN + ENTER** to simulate **ENTER** on the enhanced keyboard's numeric keypad.

Hot keys

Hot keys (pressing **FN** + a function or **ESC** key) let you enable or disable certain features of the computer.



Mute: Pressing **FN + ESC** turns the volume on and off.



Lock: Pressing **FN + F1** enters "Lock computer mode". To restore your desktop, you need to log on again.



Power Plan: Pressing **FN + F2** changes the power settings.



Sleep: Pressing **FN + F3** switches the system to Sleep mode.



Hibernate: Pressing **FN + F4** switches the system to Hibernate mode.



Output: Pressing **FN + F5** changes the active display device.



Brightness (Down): Pressing **FN + F6** decreases the computer's display panel brightness in individual steps.



Brightness (Up): Pressing **FN + F7** increases the computer's display panel brightness in individual steps.



Wireless: Pressing **FN + F8** switches the active wireless devices if the wireless communication switch is switched on.



If no wireless communication device is installed, no dialog box will appear.



Touch Pad: Pressing **FN + F9** enables or disables the Touch Pad function.



Zoom: Pressing **FN + Space** changes the display resolution.



TOSHIBA Zooming Utility (reduce): Pressing **FN + 1** reduces the icon size on the desktop or the font sizes within one of the supported application windows.



TOSHIBA Zooming Utility (enlarge): Pressing **FN + 2** enlarges the icon size on the desktop or the font sizes within one of the supported application windows.

FN Sticky key

You can use the TOSHIBA Accessibility Utility to make the **FN** key sticky, that is, you can press it once, release it, and then press an "F Number" key. To start the TOSHIBA Accessibility utility, click **Start -> All Programs -> TOSHIBA -> Utilities -> Accessibility**.

Windows special keys

The keyboard provides two keys that have special functions in Windows: Windows Start Button activates the **Start** menu and the other, the application key, has the same function as the secondary mouse button.



This key activates the Windows **Start** menu.



This key has the same function as the secondary (right) mouse button.

Keypad overlay

Your computer's keyboard does not have a separate numeric keypad but includes a numeric keypad overlay which functions like one - this is located in the center of the keyboard with the relevant keys having grey letters at their front edge. The overlay provides the same functions as the numeric keypad on a standard 104/105-key enhanced keyboard.

Turning on the overlays

The numeric keypad overlay can be used for numeric data input or cursor and page control.

Arrow mode

To turn on Arrow Mode, press **FN + F10** - the Arrow mode indicator lights and you are able to access cursor and page control functions by using the keys. You are able to press **FN + F10** again to turn off this overlay function.

Numeric mode

To turn on Numeric Mode, press **FN + F11** - the Numeric Mode indicator lights and you are able to access numeric characters by using the keys. You are able to press **FN + F11** again to turn off this overlay function.

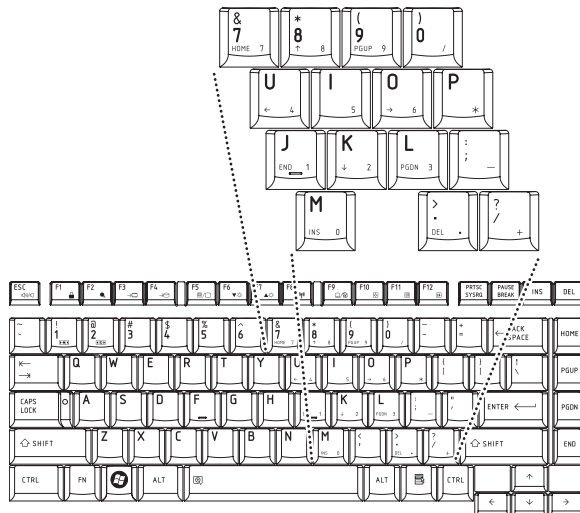

Figure 5-2 The numeric keypad overlay

Temporarily using normal keyboard (overlay on)

While using the overlay, you can temporarily access the normal keyboard functions without having to turn the overlay off:

1. Hold **FN** and press any other key - this key will operate as if the overlay were off.
2. Type upper-case characters by holding **FN + SHIFT** and pressing a character key.
3. Release **FN** to continue using the selected overlay function.

Temporarily using overlay (overlay off)

While using the normal keyboard function, you can temporarily use the keypad overlay without having to turn it on:

1. Press and hold down **FN**.
2. Check the keyboard indicators as pressing the **FN** key will turn on the most recently used overlay function - if the Numeric Mode indicator lights you can use the overlay for numeric entry, while if the Arrow Mode indicator lights, you can use the overlay for cursor and page control function.
3. Release **FN** to return to normal keyboard operation.

Temporarily changing modes

If the computer is in **Numeric Mode**, you can switch temporarily to **Arrow Mode** by pressing a **SHIFT** key, while if it is in **Arrow Mode**, you can switch temporarily to **Numeric Mode** by also pressing a **SHIFT** key.

Generating ASCII characters

Not all ASCII characters can be generated using normal keyboard operation, but you are able to generate these characters using their specific ASCII codes.

With the overlay on:

1. Hold down **ALT**.
2. Using the overlay keys, type the ASCII code of the character you require.
3. Release **ALT** - the ASCII character will appear on the display screen.

With the overlay off:

1. Hold down **ALT + FN**.
2. Using the overlay keys, type the ASCII code of the character you require.
3. Release **ALT + FN** - the ASCII character will appear on the display screen.

Chapter 6

Power and Power-up Modes

The computer's power resources include the AC adaptor and internal batteries. This chapter gives details on making the most effective use of these resources including charging and changing batteries, tips for saving battery power, and power-up modes.

Power conditions

The computer's operating capability and battery charge status are affected by different power conditions, including whether an AC adaptor is connected, whether a battery pack is installed and what the charge level is for that battery.

Table 6-1 Power conditions

		Power on	Power off (no operation)
AC adaptor connected	Battery fully charged	<ul style="list-style-type: none"> Operates LED: Battery white DC IN white 	<ul style="list-style-type: none"> LED: Battery white DC IN white
	Battery partially charged or no charge	<ul style="list-style-type: none"> Operates Quick Charge LED: Battery amber DC IN white 	<ul style="list-style-type: none"> Quick charge LED: Battery amber DC IN white
	No battery installed	<ul style="list-style-type: none"> Operates No charge LED: Battery off DC IN white 	<ul style="list-style-type: none"> No charge LED: Battery off DC IN white

Table 6-1 Power conditions continued

		Power on	Power off (no operation)
AC adaptor not connected	Battery charge is above low battery trigger point	<ul style="list-style-type: none"> Operates LED: Battery off DC IN off 	
	Battery charge is below low battery trigger point	<ul style="list-style-type: none"> Operates LED: Battery flashes Amber DC IN off 	
	Battery charge is exhausted	Computer goes into Sleep Mode and shuts down	
	No battery installed	<ul style="list-style-type: none"> Cannot operate LED: Battery off DC IN off 	

Power indicators

As shown in the below table, the **Battery**, **DC IN** and **Power** indicators on the system indicator alert you to the computer's operating capability and battery charge status.

Battery indicator

Check the **Battery** indicator to determine the status of the battery pack - the following indicator conditions should be noted:

Flashing amber	The battery charge is low, the AC adaptor must be connected in order to recharge the battery.
Amber	Indicates the AC adaptor is connected and the battery is charging.
White	Indicates the AC adaptor is connected and the battery is fully charged.
No light	Under any other conditions, the indicator does not light.



*If the battery pack becomes too hot while it is being charged, the charge will stop and the **Battery** indicator will go out. When the battery pack's temperature falls to a normal range, charging will resume - this process will occur regardless of whether the computer's power is on or off.*

DC IN indicator

Check the **DC IN** indicator to determine the power status with the AC adaptor connected - the following indicator conditions should be noted:

White	Indicates the AC adaptor is connected and is correctly supplying power to the computer.
No light	Under any other conditions, the indicator does not light.

Power indicator

Check the **Power** indicator to determine the power status of the computer - the following indicator conditions should be noted:

White	Indicates power is being supplied to the computer and the computer is turned on.
Blinking amber	Indicates that the computer is in Sleep Mode and that there is sufficient power available (AC adaptor or battery) to maintain this condition. In Sleep Mode, this indicator will turn on for one second and off for one second.
No light	Under any other conditions, the indicator does not light.

Battery types

The computer has two different types of batteries:

- Battery pack
- Real Time Clock (RTC) battery

Battery pack

When the AC adaptor is not connected, the computer's main power source is a removable lithium ion battery pack, also referred to in this manual as the battery. You can purchase additional battery packs for extended use of the computer away from an AC power source although you should not change the battery pack while the AC adaptor is connected.

Before you remove the battery pack, save your data and shut down the computer, or place the computer into Hibernation Mode. Please be aware that, when placing the computer into Hibernation Mode, the contents of memory will be saved to the hard disk drive, although for safety sake, it is best to also save your data manually.



- *The battery pack is a lithium ion battery, which can explode if not properly replaced, used, handled or disposed of. Dispose of the battery as required by local ordinances or regulations. Use only batteries recommended by TOSHIBA as replacements.*
- *Do not remove the battery pack while the computer is in Sleep Mode. In this mode data is stored in memory, so if the computer loses power, it will be lost.*
- *Battery type (depending on the model you purchased)*
- *The availability of this battery is dependent on the model you purchased.*

Real Time Clock battery

The Real Time Clock (RTC) battery provides power for the internal real time clock and calendar function and also maintains the system configuration while the computer is turned off. If the RTC battery becomes completely discharged, the system will lose this information and the real time clock and calendar will stop working - in this instance the following message will be displayed when you turn on the power:

S

```
ERROR 0271: Check date and time settings.
WARNING 0251: System CMOS checksum bad - Default
configuration used.
Press <F1> to resume, <F2> to Setup.
```



The computer's RTC battery is a lithium battery and should be replaced only by your dealer or by a TOSHIBA service representative. The battery can explode if not properly replaced, used, handled or disposed of. Dispose of the battery as required by local ordinances or regulations.

When this error appears, the following action is recommended.

1. Connect the AC adapter and let the battery charge for 24-hours.
2. Press F2 to enter BIOS setup menu.
3. Set correct time and date.



If you still see the error message after performing the above actions, please contact your TOSHIBA service representative.

Care and use of the battery pack

The battery pack is a vital component of portable computing and, as such, taking proper care of it will help ensure a longer operating time on battery power as well as deliver a longer life for your battery pack. The instructions detailed in this section will help to ensure safe operation and maximum performance.

Refer to the enclosed **Instruction Manual for Safety and Comfort** for detailed precautions and handling instructions.



- *Make sure the battery is securely installed in the computer before attempting to charge the battery pack. Improper installation could generate smoke or fire, or cause the battery pack to rupture.*
- *Keep the battery pack out of reach of infants and children. It can cause injury.*



- *The battery pack is lithium ion battery, which can explode if not replaced, used, handled or disposed of properly. Dispose of the battery as required by local ordinances or regulations. Use only batteries recommended by TOSHIBA as replacements.*
- *Charge the battery pack only in an ambient temperature between 5 and 35 degrees Celsius. Otherwise, the electrolyte solution might leak, battery pack performance might deteriorate and the battery life might be shortened.*
- *Never install or remove the battery pack without first turning off the power and disconnecting the AC adaptor. Never remove the battery pack while the computer is in Sleep Mode. Data will be lost.*



- *Never remove the battery pack while the Wake-up on LAN function is enabled. Data will be lost. Before you remove a battery pack, disable the Wake-up on LAN function.*

Charging the batteries

When the power in the battery pack becomes low, the **Battery** indicator will flash amber to indicate that only a few minutes of battery power remain. If you continue to use the computer while the **Battery** indicator flashes, the computer will enable Hibernation Mode so that you do not lose any data, and automatically turn itself off.

You must recharge a battery pack when it becomes discharged.

Procedures

To recharge a battery pack while it is installed in the computer, connect the AC adaptor to the DC IN 19V jack and plug the other end into a working outlet - the **Battery** indicator will glow amber while the battery is being charged.



Use only the computer connected to an AC power source or the optional TOSHIBA Battery charger to charge the battery pack. Never attempt to charge the battery pack with any other charger.

Time

The following table shows the approximate time required to fully charge a discharged battery.

Battery type	Charging time (hours)	
	Power on	Power off
Battery Pack (3 cell / 6 cell / 9 cell)	about 12 or longer	about 4 or longer
RTC battery	about 24	about 24 with AC or Battery pack



Please be aware that the charging time when the computer is on is affected by ambient temperature, the temperature of the computer and how you are using the computer - if you make heavy use of external devices for example, the battery might scarcely charge at all during operation. Please refer to the section [Maximizing battery operating time](#) for further information.

Battery charging notice

The battery may not begin charging immediately under the following conditions:

- The battery is extremely hot or cold (if the battery is extremely hot, it might not charge at all). To ensure the battery charges to its full capacity, you should charge it at room temperature of between 5° to 35°C (41° to 95°F).
- The battery is nearly completely discharged. In this instance you should leave the AC adaptor connected for a few minutes and the battery should begin charging.

The **Battery** indicator may show a rapid decrease in battery operating time when you try to charge a battery under the following conditions:

- The battery has not been used for a long time.
- The battery has completely discharged and been left in the computer for a long time.
- A cool battery is installed in a warm computer.

In such cases you should follow the steps as detailed below:

1. Fully discharge the battery by leaving it in the computer with the power on until the system automatically turns itself off.
2. Connect the AC adaptor to the DC IN 19V jack of the computer, and to a wall outlet that is supplying power.
3. Charge the battery until the **Battery** indicator glows white.

Repeat these steps two or three times until the battery recovers normal capacity.

Monitoring battery capacity

Remaining battery power can be monitored using the following methods.

- Clicking the battery icon on the task bar
- Via the Battery Status in the Windows Mobility Center window



- *You should wait at least 16 seconds after turning on the computer before trying to monitor the remaining operating time. This is because the computer needs this time to check the battery's remaining capacity and then calculate the remaining operating time, based on this together with the current power consumption.*
- *Please be aware that the actual remaining operating time may differ slightly from the calculated time.*
- *With repeated discharges and recharges, the battery's capacity will gradually decrease. In view of this it will be noted that an often used, older battery will not operate for as long as a new battery even when both are fully charged.*

Maximizing battery operating time

A battery's usefulness depends on how long it can supply power on a single charge, while how long the charge lasts in a battery depends on:

- Processor speed
- Screen brightness
- System Sleep Mode
- System Hibernation Mode
- Display power off period
- Hard disk drive power off period
- How often and for how long you use the hard disk drive, optical disc and floppy diskette drives.
- How much charge the battery contained to begin with.
- How you use optional devices, such as a PC Cards, to which the battery supplies power.
- Whether you enable Sleep Mode, which can conserve battery power if you are frequently turning the computer off and on.
- Where you store your programs and data.
- Whether you close the display panel when you are not using the keyboard - closing the display saves power.
- The environmental temperature - operating time decreases at low temperatures.
- The condition of the battery terminals - you should always ensure the terminals stay clean by wiping them with a clean dry cloth before installing the battery pack.

Retaining data with power off

When you turn off your computer with fully charged batteries, the batteries retain data for the following approximate time periods.

Retention Time	
Battery type	State and Retention Time
Battery pack	1.5day for 9cell, 1day for 6cell, 0.5day for 3cell (sleep mode)
	15day for 9cell, 10day for 6cell, 5day for 3cell (shut down mode)
RTC battery	30 days

Extending battery life

To maximize the life of your battery packs:

- At least once a month, disconnect the computer from a power source and operate it on battery power until the battery pack fully discharges. Before doing so, follow the steps as detailed below.
 1. Turn off the computer's power.
 2. Disconnect the AC adaptor and turn on the computer's power - if it does not turn on then go to Step 4.
 3. Operate the computer on battery power for five minutes. If you find that the battery pack has at least five minutes of operating time, continue operating until the battery pack is fully discharged, however, if the **Battery** indicator flashes or there is some other warning to indicate a low battery condition, go to Step 4.
 4. Connect the AC adaptor to the DC IN 19V jack of the computer, and to a wall outlet that is supplying power. The **DC IN** indicator should glow white, and the **Battery** indicator should glow amber to indicate that the battery pack is being charged, however, in the event that **DC IN** indicator does not glow this indicates that power is not being supplied - check the connections for the AC adaptor and the power cord.
 5. Charge the battery pack until the **Battery** indicator glows white.
- If you have extra battery packs, rotate their use.
- If you will not be using the system for an extended period, for example for more than one month, remove the battery pack from the computer.
- Disconnect the AC adaptor when the battery is fully charged - overcharging will make the battery hot and can shorten its operating life.
- If you are not going to use the computer for more than eight hours, disconnect the AC adaptor.
- Store spare battery packs in a cool dry place out of direct sunlight.

Replacing the battery pack

Please be aware that the battery pack is classified as a consumable item. The operating life of the battery pack will gradually reduce through repeated charging and discharging, and will need to be replaced when it reaches the end of its operating life. In addition to this, you might also replace a discharged battery pack with a charged spare when you are operating your computer away from an AC power source for an extended period of time.

This section explains how to remove and install the battery pack, and begins with the removal process which is detailed through the following steps.



- *Do not remove the battery pack while the computer is in Sleep Mode. Data is stored in RAM, so if the computer loses power it will be lost.*
- *In Hibernation Mode, data will be lost if you remove the battery pack or disconnect the AC adaptor before the save is completed. Wait for the **Hard Disk Drive** indicator to go out.*
- *Do not touch the battery release latch while holding the computer or the battery pack might fall out due to the unintentional release of the battery release latch and cause injuries.*

To remove a discharged battery, follow the steps as detailed below:

1. Save your work.
2. Turn the computer's power off - ensure that the **Power** indicator is off.
3. Remove all cables and peripherals that are connected to the computer.
4. Close the display panel and turn the computer upside down.

- Slide the battery safety lock towards the release () position to make the battery release latch movable.

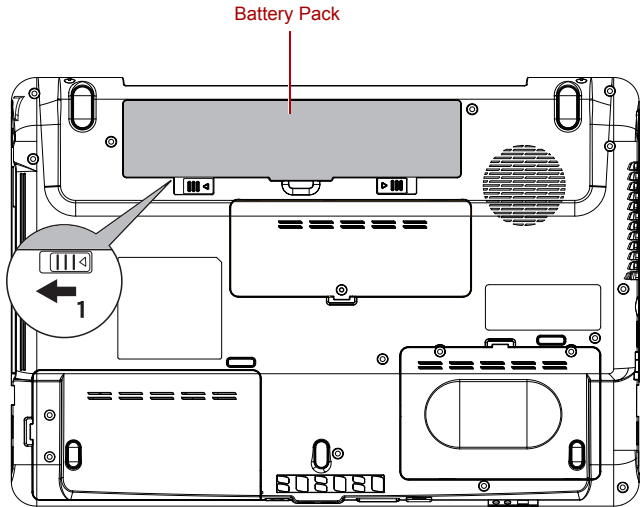

Figure 6-1 Releasing the battery pack (1)

- Slide and hold the battery release latch (1) to disengage the battery pack and then remove it from the computer (2).

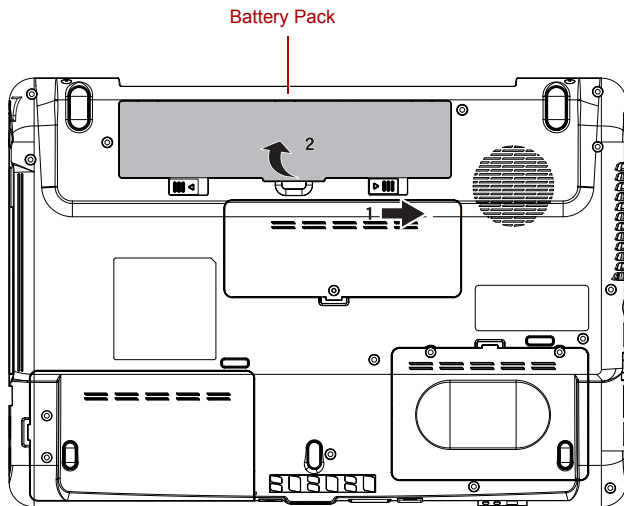

Figure 6-2 Releasing the battery pack (2)

To install a battery, follow the steps as detailed below:

1. Insert the battery pack as far as it will go into the computer (1).
2. Ensure that the battery pack is securely in place and the battery safety lock (2) is in its position.

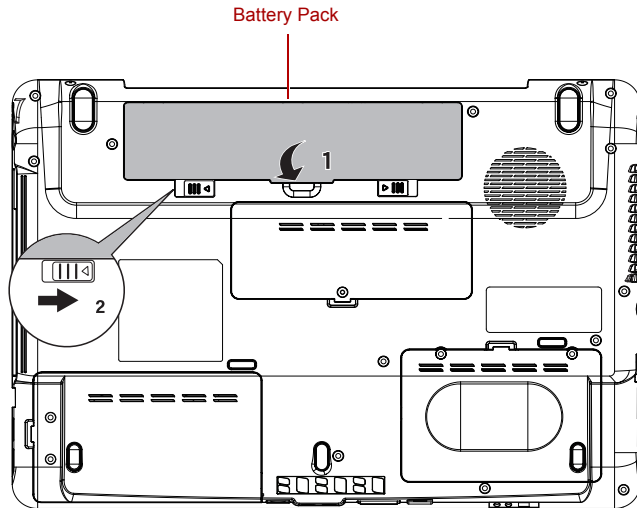

Figure 6-3 Securing the battery pack

3. Turn your computer over.

TOSHIBA Password Utility

The TOSHIBA Supervisor Password Utility provides two levels of password security: User and Supervisor.



Passwords set in TOSHIBA Supervisor Password Utility are different from the Windows® login password.

User Password

To start the utility, point to or click the following items:

Launch TOSHIBA Assist → SECURE → User Password

- **Registered**

Click to register a password of up to 8 characters. After a password is set, you will be prompted to enter it when you start the computer.

- **Not Registered**

Click to delete a registered password. Before you can delete a password, you must first enter the current password correctly.

- **Owner String** (text box)

You can use this box to associate text with the password. After you enter text, click Apply or OK, then, each time the computer is switched on, this text will be displayed along with the prompt for the password.

Supervisor password

If you set a supervisor password, some functions will be restricted when a user logs on with the user password. To set a supervisor password:

TOSHIBA Assist → SECURE → Supervisor password

This utility lets you do the following:

- Register or delete the supervisor password.
- Specify restrictions for general users.

Starting the computer by password

If you have already registered a password, there are two ways to start the computer:

- Swipe your fingerprint on the sensor if you have already registered the fingerprint with the Fingerprint utility and enabled **Fingerprint Power-on Security**. If you would not like to swipe your finger or cannot authenticate the fingerprint for some reasons, push the **BkSp** key to skip the fingerprint authentication screen. You can try to swipe the fingerprint up to five times. If you failed fingerprint authentication more than five times, you must enter the password manually to start the computer.
- Enter the password manually.



The password is necessary only if the computer was shut down in boot mode, not in Hibernation or Sleep mode.

To enter a password manually, follow these steps:

1. Turn on the power as described in Chapter 3, Getting Started. The following message will appear in the LCD:

Enter Password [xxxxxxxx]



*At this point, the hotkeys **Fn + F1** to **F9** do not work. They will function after you enter the password.*

2. Enter the Password.
3. Press **Enter**.



If you enter the password incorrectly three consecutive times, the computer shuts down. You must turn on the computer again and re-enter the password.

Power-up modes

The computer has three power-up modes:

- Hibernation (saves data in memory to the hard disk)
- Sleep (power remains on, maintaining the data in memory, but the CPU and all other devices effectively enter a 'sleep' mode)
- Boot (does not save data in memory)



Refer also to the section [Turning off the power](#) in Chapter 3, [Getting Started](#).

Windows utilities

You can configure various settings associated with both Sleep Mode and Hibernation Mode within the Power Options (to access it, **Start** -> **Control Panel** -> **System and Maintenance** -> **Power Options**).

Hot keys

You can use the **FN + F3** hot key to enter Sleep Mode or **FN + F4** to enter Hibernation Mode - please refer to Chapter 5, [The Keyboard](#) for further details.

Panel power on/off

You can set up your computer so that power is turned off automatically when you close the display panel, and turned on again when you open it. Please note that this function is only available for Sleep Mode or Hibernation Mode, not for Shut Down Mode.



If the panel power off function is enabled, and you manually shut down Windows, do not close the computer's display panel until the shut down process has been completed.

System auto off

This feature turns the system off automatically if it is not used for a set duration. The system shuts down in sleep mode or hibernation mode.

Chapter 7

HW Setup and Passwords

This chapter explains how to use TOSHIBA HW Setup program to configure your computer and how to set passwords.

HW Setup

TOSHIBA HW Setup allows you to configure settings for General, Password, Display, Boot Priority, Keyboard, USB, LAN and LED Illumination.



If the supervisor password is set, access to the TOSHIBA HW Setup program can be prevented when the user password is used to log on to the computer.

Accessing HW Setup

Start, point to All Programs, point to TOSHIBA, point to Utilities and click HWSetup.

HW Setup Window

The HW Setup window contains the following tabs: General, Password, Display, Boot Priority, CPU, Keyboard, LAN, and USB.

There are also these three buttons:

OK	Accepts your changes and closes the HW Setup window.
Cancel	Closes the window without accepting your changes.
Apply	Accepts all your changes without closing the HW Setup window.

General

This window displays the BIOS version and contains two buttons:

Default	Return all HW Setup values to the factory settings.
About	Display the HW Setup version.

Setup

This field displays BIOS Version and date.



When finish BIOS update, please restart your computer and press F2 into BIOS setup manual and load BIOS default one time.

Password

User Password

This option allows you to set or reset the user password for power on.

Not Registered	Changes or remove the password. (Default)
Registered	Sets the password. A dialogue box will appear to allow you to set the password.

To enter a user password:

1. Select Registered to display the following prompt:

Enter Password:

Enter a password of up to 10 characters. The character string you enter is displayed as a string of asterisks. For example, if you enter a password consisting of four characters, the display is shown as:

Enter Password: ****

2. Click the OK button. The following message appears, allowing you to verify the password.

Verify Password:

3. If character strings match, the password is registered click OK button. If they do not match, the following message appears. You must repeat from step 1.

Entry Error!!!

To delete a user password:

1. Select Not Registered to display the following prompt:

Enter Password:

2. Enter the currently registered password. The character string you enter is displayed as a string of asterisks.

Enter Password: ****

3. Click the OK button. If the character string you enter matches the registered password, the password option is reset and the display changes to:

Not registered

If they do not match, the following message appears. You must repeat step 1.

Incorrect Password!!!



If you enter the password incorrectly three times in a row, the computer need to shut off.

You will not be able to access the password option in the HW Setup. In this case you must turn the power off and back on to retry the procedure.

4. Follow the same procedures described in the earlier section, How to set the password, to set a new user password.

Display

This tab allows you to customize your computer's display settings for either the internal LCD screen or for an external monitor.

Power On Display

Allows you to set the display to be used when the computer is booted.

Auto-Selected	Selects an external monitor if one is connected, otherwise, it selects the internal LCD display (Default).
LCD + Analog RGB	Selects both the internal LCD and an external monitor for simultaneous display.

Boot Priority

Boot Priority Options

This option sets the priority for booting the computer.

Select the boot priority from the drop down list.

You can override the settings and manually select a boot device by pressing one of the following keys while the computer is booting:

F	Selects the USB floppy disk drive.
L	Selects the Network.
C	Selects optical device.

To select the boot drive you want, follow the steps below.

1. Boot-up your computer and press **F12 to enter the boot menu**.
2. The boot select screen will be displayed: HDD1, HDD2, CD/DVD, and LAN.
3. Use the upper/lower cursor keys to highlight the boot device you want and press **Enter**.

Keyboard

Wake-up on Keyboard

When this feature is enabled and the computer is in Sleep mode, you can turn on the computer by pressing any key. It is effective only for the internal keyboard and only when the computer is in Sleep mode.

Enabled	Enables the Wake-up on Keyboard feature.
Disabled	Disables the Wake-up on Keyboard function (Default).

USB

Legacy USB Support

Use this option to enable or disable USB Legacy Emulation. If your operating system does not support USB, you can still use a USB mouse and keyboard by setting the **USB Legacy Emulation** item to enabled.

Enabled	Enables the USB Legacy Emulation. (Default)
Disabled	Disables the USB Legacy Emulation.

USB Sleep and Charge function

This section describes the setting for USB Sleep and Charge function. For more information, please refer to the [USB Sleep and Charge function](#) section in Chapter 4.

The default setting in BIOS Setup is [Disabled]. Changing the setting to [Enabled] enables the use of this function.

There are two modes, Mode 1 and Mode 2 in [Enabled]. For normal use, set the setting to Mode 1.



If the function does not work with Mode-1 setting, change it to Mode-2. Some external devices may not be able to use this function in either mode. When this happens, change the setting to [Disabled].

Enabled (Mode 1)	Enables Sleep and Charge function Mode 1.
Enabled (Mode 2)	Enables Sleep and Charge function Mode 2.
Disabled	Disables Sleep and Charge function. (Default)

LAN

Wake-up on LAN

This feature lets the computer's power be turned on when it receives a wakeup signal from the LAN.

Enabled	Enables Wake-up on LAN.
Disabled	Disables Wake-up on LAN (Default).



The Wake-up on LAN function consumes power even when the system is off. Leave the AC adaptor connected while using this feature.



Do not install or remove an optional memory module while Wake-up on LAN is enabled.

Built-in LAN

This feature enables or disables the Built-in LAN.

Enabled	Enables Built-in LAN function (Default).
Disabled	Disables Built-in LAN function.

illumination

illumination ON/OFF

This feature allows you to set conditions for Front Edge Logo LED, touchpad illumination LED and Function button backlight LED. (Depending on the model you purchased)

ON	On. (Default)
OFF	Off.

Chapter 8

Optional Devices

Optional devices can expand the computer's capabilities and its versatility. This chapter describes the connection or installation of the following devices:



To connect optional devices (such as USB device or External monitor) to the computer, be sure to check the shape and orientation of the connector before connecting.

Cards/memory

- ExpressCard
- Bridge media slot
 - Secure Digital (SD) Card (SD memory card, SDHC memory card, miniSD Card, microSD Card)
 - Memory Stick (Memory Stick, Memory Stick PRO, Memory Stick PRO Duo)
 - xD picture card
 - MultiMediaCard
- Memory expansion

Power devices

- Battery packs
- Universal AC Adaptor
- Battery Charger

Peripheral devices

- Hard disk drive pack
- USB floppy diskette drive
- eSATA
- External monitor
- HDMI
- i.LINK (IEEE1394)

Other

- Security lock

ExpressCard

The computer is equipped with a single ExpressCard slot into which any ExpressCard device that meets industry standards, either manufactured by TOSHIBA or another vendor, can be installed. The slot supports hot plug connection and utilizes the PCI Express interface that supports the reading and writing of data at a theoretical maximum rate of 2.5Gbps.

Inserting an ExpressCard

The Windows hot-install feature allows you to insert ExpressCards while the computer is turned on.



- *Do not insert an ExpressCard while the computer is in Sleep Mode or Hibernation Mode as you may find that some cards do not work properly.*

To insert an ExpressCard, follow the steps as detailed below:

1. Press the PC Card eject button to partially extend it out of the computer.
2. Press the extended PC Card eject button in order to eject the Dummy card partially out of the computer.
3. Grasp the Dummy card and draw it.
4. Insert the ExpressCard into the ExpressCard slot on the side of the computer.
5. Press the ExpressCard gently to ensure a firm connection is made.

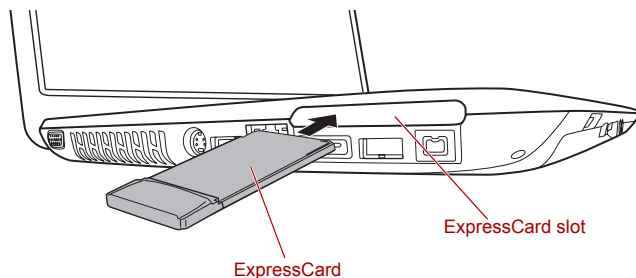

Figure 8-1 Inserting the ExpressCard

6. After inserting the ExpressCard you should refer to its documentation and also check the configuration in Windows in order to ensure that it is correct.

Removing an ExpressCard

To remove an ExpressCard, follow the steps as detailed below.

1. Open the **Safely Remove Hardware** icon on the Windows Task Bar.
2. Point to **ExpressCard** and click the left Touch Pad control button.
3. Press the ExpressCard eject button to partially extend it out of the computer.



If the ExpressCard is not inserted all the way into the computer, the eject button may not cause it to pop out sufficiently to allow it to be grasped. In this instance, simply push the ExpressCard firmly back into the computer and then press the eject button again.

4. Press the extended eject button in order to eject the ExpressCard partially out of the computer.
5. Grasp the ExpressCard and remove it.

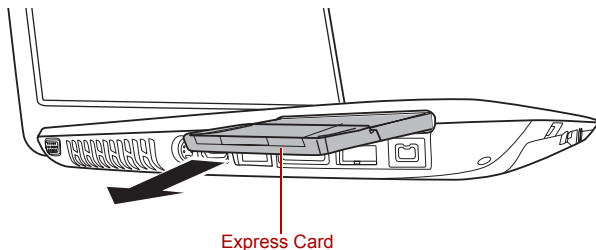

Figure 8-2 Removing the ExpressCard

6. Insert the Dummy card into the PC Card slot.



When you do not use a PC card, please be sure to insert a Dummy card.

Bridge media slot

The computer is equipped with a Bridge media slot that can accommodate some kinds of memory media with various memory capacities so that you can easily transfer data from devices, such as digital cameras and Personal Digital Assistants.



- *Keep foreign objects out of the Bridge media slot. Never allow metal objects, such as screws, staples and paper clips, to enter the computer or Keyboard. Foreign metal objects can create a short circuit, which can cause computer damage and fire, possibly resulting in serious injury.*



- This Bridge media slot supports the following memory media.
 - Secure Digital (SD) Card (SD memory card, SDHC memory card, miniSD Card, microSD Card)
 - Memory Stick (Memory Stick, Memory Stick PRO, Memory Stick PRO Duo)
 - xD picture card
 - MultiMediaCard (MMC)
- Please note that an adaptor is required to use miniSD/microSD Card.
- Please note that not all memory media have been tested and verified to work correctly. Therefore, it is not possible to guarantee that all memory media will operate properly.
- The slot does not support Magic Gate functions.

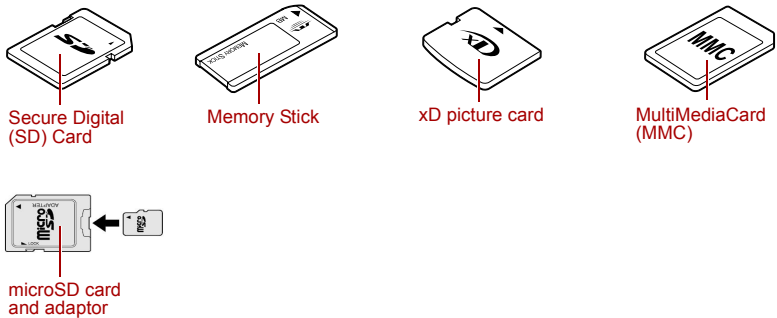

Figure 8-3 Examples of memory media

Memory media

This section provides the important safety precautions in order to handle your memory media.



Points to note about the SD/SDHC memory card

SD/SDHC memory cards comply with SDMI (Secure Digital Music Initiative), which is a technology adopted to prevent unlawful copy or playback of digital music. For this reason, you cannot copy or playback protected material on another computer or other device, and you may not reproduce any copyrighted material except for your personal enjoyment.

Below is a simple explanation for distinguishing SD memory cards from SDHC memory cards.

- SD and SDHC memory cards appear the same externally.
- The logo on SD and SDHC memory cards is different, so pay careful attention to the logo when purchasing.



- The SD memory card logo is ().
- The SDHC memory card logo is ().
- The maximum capacity of SD memory cards is 2GB. The maximum capacity of SDHC memory cards is 16G.

Card Type	Capacities
SD	8MB, 16MB, 32MB, 64MB, 128MB, 256MB, 512MB, 1GB, 2GB
SDHC	4GB, 8GB, 16GB

Memory media format

New media cards are formatted according to specific standards. If you wish to reformat a media card, be sure to do so with a device that uses media cards.

Formatting an SD/SDHC memory card

SD/SDHC memory cards are sold already formatted in conformity to specific standards. If you reformat an SD/SDHC memory card, be sure to reformat it with a device such as digital camera or digital audio player that uses the SD/SDHC memory cards, not with the format command provided within Windows.

Additional memory module

You can install additional memory into the computer in order to increase the amount of system memory that is available. This section describes how to install and remove optional memory modules.



- *You should place a mat beneath the computer in order to prevent the computer's lid from becoming scratched or damaged when you are installing/replacing the memory module. In this instance you should avoid mats that are made of materials that hold or generate static electricity.*
- *When installing or removing a memory module, you must ensure that you do not touch any other internal areas of the computer.*
- *Insert the two memory modules into Slot A and Slot B respectively. The computer will operate in dual channel mode. You can access the inserted memory modules efficiently in dual channel.*



- Use only memory modules approved by TOSHIBA.
- Do not try to install or remove a memory module under the following conditions.
 - a. The computer is turned on.
 - b. The computer was shut down in either Sleep or Hibernation Mode.
 - c. Wake-up on LAN is enabled.
 - d. The wireless communication switch is turned on.
- Be careful not to let screws or other foreign matter fall into the computer. It could cause malfunction or electric shock.
- Additional memory module is a precision electronic component that may be fatally damaged by static electricity. Since the human body can carry static electricity, it is important that you discharge yourself before touching or installing any additional memory modules. To discharge your body's static electricity, simply touch any metal close to you with bare hands.
- In order to ensure that the computer power is not turned on while working, set the Wireless communication switch to OFF.

Point to note about memory module error

If you install a memory module that is not compatible with the computer, the **Power** indicator will flash in the following ways;

- If there is an error in only Slot A or no memory module is inserted in Slot A: repeatedly flashes amber twice, then green.
- If there is an error in Slot B: repeatedly flashes amber, then green twice.
- If there are errors in both Slot A and Slot B: repeatedly flashes amber twice, then green twice.

In all instances you should shut down the computer and remove the incompatible module(s).



Use a #0 point Phillips screwdriver to remove and fasten the screws - the use of an incorrect screwdriver can damage the screw heads.

Installing a memory module

The computer contains slots for two memory modules, one positioned in front of the other - the procedures are the same for installing either module.

1. Shut down the computer - make sure the Power indicator is off (refer to the [Turning off the power](#) section in Chapter 3, [Getting Started](#) if required).
2. Remove the AC adaptor and all cables and peripherals connected to the computer.

3. Turn the computer upside down and remove the memory module cover.

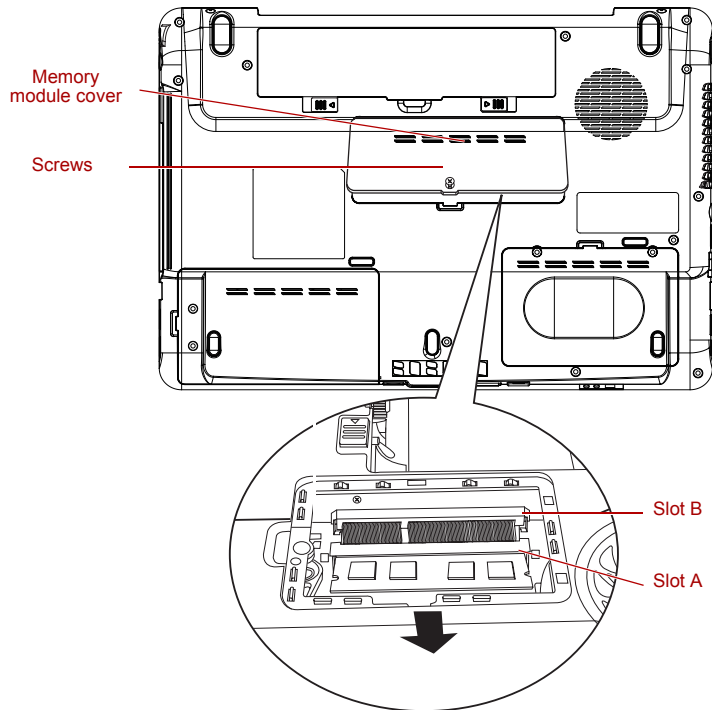

Figure 8-4 Removing the memory module cover

4. Align the notch of the memory module with that of the memory module slot and gently insert the module into the slot at about a 45 degree angle before holding it down until the latches on either side snap into place.



- *Align the grooves along the edges of the memory module with the locking tabs on the connector and insert the memory module into the connector firmly - if you find it difficult to install the memory module, gently prise the locking tabs outwards using the tip of your finger. Please also ensure that you hold the memory module along its left and right hand edges - the edges with the grooves in.*



- *Never allow metal objects, such as screws, staples and paper clips, to enter the computer or keyboard. Foreign metal objects can create a short circuit, which can cause computer damage and fire, possibly resulting in serious injury.*
- *Do not touch the connectors on the memory module or on the computer. Debris on the connectors may cause memory access problems.*

5. Seat the memory module cover in place and secure it with one screw.



Take care to ensure that the memory module cover is firmly closed.

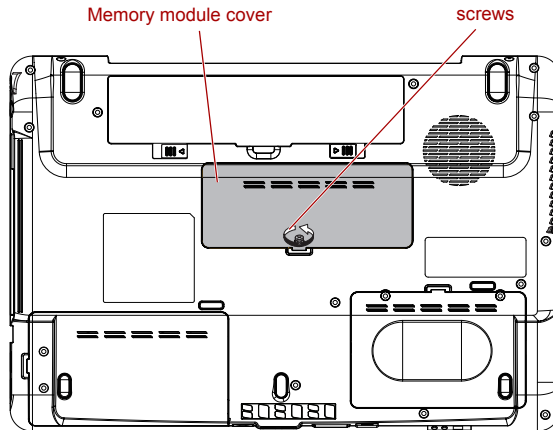

Figure 8-5 Seating the memory module cover

6. Install the battery pack - refer to [Replacing the battery pack](#) section in Chapter 6, [Power and Power-up Modes](#), if required.
7. Turn your computer over.
8. Turn the computer on and make sure the added memory is recognized - to confirmed it, **Start** -> **Control Panel** -> **System and Maintenance** -> **System** icon.

Removing a memory module

To remove the memory module, follow the steps as detailed below:

1. Set the computer to Boot Mode and turn its power off - make sure the **Power** indicator is off (refer to the [Turning on the power](#) section in Chapter 3, [Getting Started](#) if required).
2. Remove the AC adaptor and all cables and peripherals connected to the computer.

3. Turn the computer upside down and remove the battery pack (refer to [Replacing the battery pack](#) section in Chapter 6, [Power and Power-up Modes](#), if required).
4. Push the latches away from the module in order to release it.
5. Grasp the memory module by its edges and remove it from the computer.



- *If you use the computer for a long time, the memory modules and the circuits locating close to the memory modules will become hot. In this case, let them cool to room temperature before you replace them. Or you will get burnt if you touch any of them.*
- *Do not touch the connectors on the memory module or on the computer. Debris on the connectors may cause memory access problems.*

6. Seat the memory module cover in place and secure it with one screw.



Take care to ensure that the memory module cover is firmly closed.

7. Install the battery pack - refer to [Replacing the battery pack](#) section in Chapter 6, [Power and Power-up Modes](#), if required.
8. Turn your computer over.

Battery Packs

You can increase the portability of the computer with additional battery packs so that, if you're away from an AC power source and your battery runs low, you can replace it with a freshly charged battery. Please refer to Chapter 6, [Power and Power-up Modes](#) for further information.

Universal AC Adaptor

If you frequently use your computer at more than one site, it may be convenient to purchase an additional AC adaptor to be kept at each site in order to remove the need to always carry the adaptor with you.

Battery Charger

The battery charger provides a convenient way to charge up to two Lithium Ion battery packs without requiring the use of your computer.

USB floppy diskette drive

The USB floppy diskette drive accommodates either a 1.44MB or 720KB a 3 2/1" floppy diskette and connects to one of the computer's USB ports.



The USB floppy diskette drive is available only as an option.

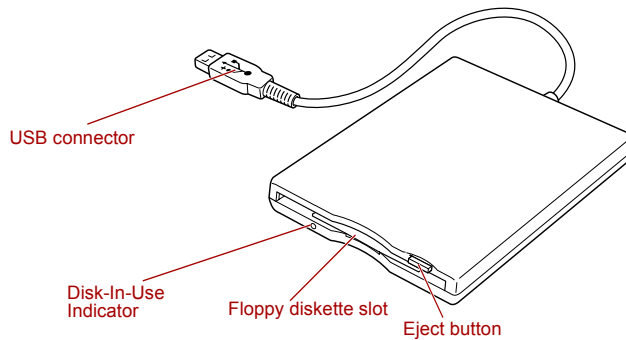

Figure 8-6 USB floppy diskette drive

USB connector	Insert this connector into one of the free USB ports of your computer.
Disk-In-Use Indicator	This indicator glows when the floppy diskette is being accessed.
Floppy diskette slot	Insert a floppy diskette into this slot.
Eject button	When a floppy diskette is fully seated in the drive, the eject button will pop out. In order to remove the diskette, push the eject button in order to cause it to partially pop out of the drive and then remove it.



*Check the **Disk-In-Use** indicator when you use the floppy diskette drive. Do not press the eject button or turn off the computer while the light is glowing. Doing so could destroy data and damage the floppy diskette or the drive.*



In use, the following should be noted regarding the operation of the USB floppy diskette drive:

- *The drive should be placed on a flat, horizontal surface.*
- *Do not set the drive on an incline greater than 20° while it is operating.*
- *Do not place anything on top of the drive.*

Using the USB floppy diskette drive

The USB floppy diskette drive accommodates either a 1.44MB or 720KB floppy diskette and connects to one of the computer's USB ports.

Connecting the USB floppy diskette drive

To connect the drive, plug the floppy diskette drive's USB connector into one of the computer's free USB ports.



Make sure the connector is right side up and properly aligned with the socket. Do not try to force the connection; doing so can damage the connecting pins.

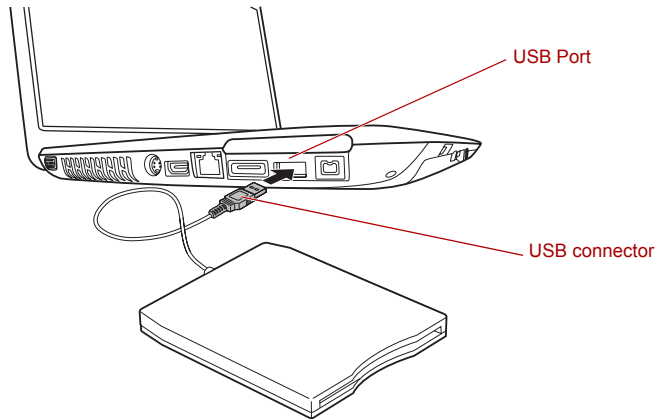

Figure 8-7 Connecting the USB floppy diskette drive



If you connect the USB floppy diskette drive after the computer has already been turned on, it will take about ten seconds for it to be recognized by the computer. Do not attempt to disconnect and reconnect the drive before this period has elapsed.

Disconnecting the USB floppy diskette drive

When you have finished using the USB floppy diskette drive, you can follow the procedures below in order to disconnect it:

1. Wait for the Disk-In-Use Indicator light to go out to make sure all floppy diskette activity has stopped.



If you disconnect the floppy diskette drive or turn off the power while the computer is accessing the drive you may lose data or damage the floppy diskette or the drive.

2. Click the **Safely Remove Hardware** icon on the Task Bar.
3. Click the USB floppy diskette drive device that you want to remove.
4. Carefully pull the floppy diskette drive's USB connector out from within the computer's USB port.

eSATA (External Serial ATA)

An device corresponding to eSATA function can be connected to the USB (eSATA combo) port on the computer.

Connecting the eSATA device

To connect an eSATA device, follow the steps as detailed below:

1. Connect an eSATA cable to the eSATA/USB combo port.



Make sure the connector is properly aligned with the socket. Do not try to force the connection, doing so can damage the connecting pins.

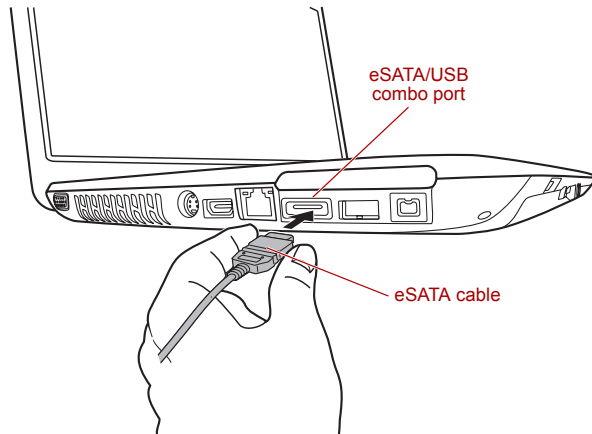

Figure 8-8 Connecting an eSATA cable to the USB (eSATA combo) port



- *A connected eSATA device may not be recognized if it is connected to the computer's eSATA/USB combo port while the computer is in Sleep Mode or Hibernation Mode. If this occurs, disconnect the eSATA device and then reconnect the device while the computer is turned on.*
- *If you connect an eSATA device after the computer has already been turned on, it will take about ten seconds for it to be recognized by the computer. Do not attempt to disconnect and reconnect the drive before this period has elapsed.*

Disconnecting an eSATA device

When you have finished using an eSATA device, you can follow the procedures below in order to disconnect it:

1. Wait for the indicator light of an eSATA device to go out to make sure all activity has stopped.



If you disconnect an eSATA device or turn off the power while the computer is accessing the drive you may lose data or damage an eSATA device or the drive.

2. Click the **Safely Remove Hardware** icon on the Windows Taskbar.
3. Click an eSATA device that you want to remove.

- Carefully pull an eSATA device's USB (eSATA combo) connector out from within the computer's USB (eSATA combo) port.

External monitor

An external analog monitor can be connected to the computer's external monitor port, with the computer supporting WUXGA video mode. In order to connect a monitor, follow the steps as detailed below:

- Turn the computer's power off.
- Connect the monitor cable to the external monitor port and tighten the screws on the left and right hand side of the connector as required.

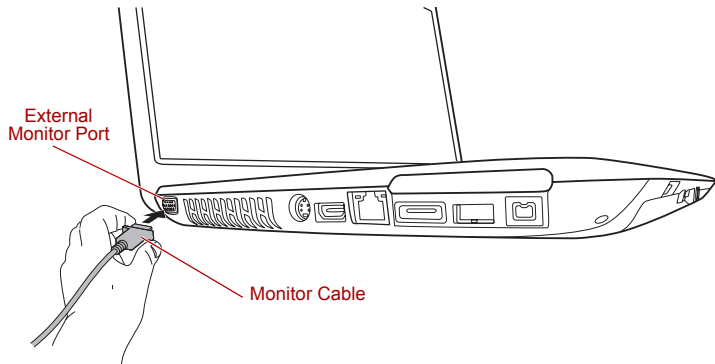

Figure 8-9 Connecting the monitor cable to the external monitor port

- Turn the external monitor's power on.
- Turn the computer's power on.

When you turn on the power, the computer will automatically recognize the monitor and determine whether it is a color or monochrome device. In the event that you find that there are issues getting an image displayed on the correct monitor, you should consider using the **FN + F5** hot key to change the display settings (if you then disconnect the external monitor before you turn the computer's power off, be sure to press **FN + F5** hot key again to switch to the internal display).

Please refer to Chapter 5, *The Keyboard*, for further details on using hot keys to change the display setting.



Do not disconnect the external monitor while in Sleep or Hibernation Mode. Turn off the computer before disconnecting the external monitor.

HDMI

The Video data on your computer can be viewed on a TV set. To do so, connect your computer's HDMI out port to the TV using the HDMI out cable.

You can use the hotkeys **FN + F5** to change the display device. Refer to Chapter 5, *The Keyboard*.



As the port operation of all HDMI (High-Definition Multimedia Interface) monitors have not been confirmed, some HDMI monitors may not function properly.

Connecting the HDMI out port

1. Plug one end of the HDMI cable into the HDMI out port of the HDMI device.

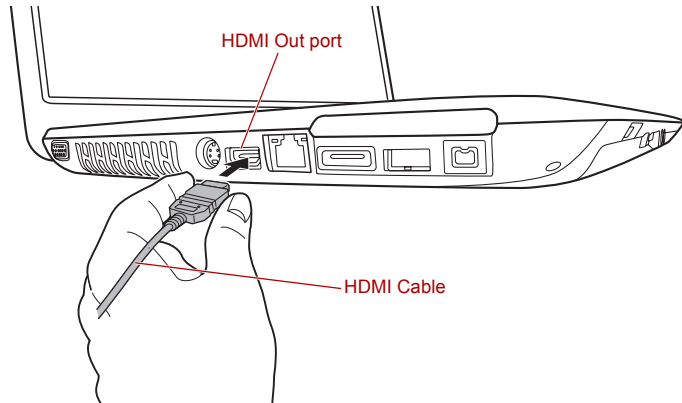

Figure 8-10 Connecting the HDMI out port

2. Plug the other end of the HDMI cable into the HDMI out port on your computer.



When connecting or disconnecting an HDMI device to or from the computer, only do so when the computer is turned on or when the computer is completely turned off. Do not do so when the computer is in Sleep Mode or Hibernation Mode.

Settings for display video on HDMI

To view video on the HDMI device, be sure to configure the following settings otherwise you may find that nothing is displayed.



- *Be sure to use the **FN + F5** HotKey to select the display device before starting to play video. Do not change the display device while playing video.*
- *Do not change the display device under the following conditions.*
 - *While data is being read or written.*
 - *While communication is being carried out.*

Select HD Format

To select the display mode, follow the steps as detailed below:

1. Click **Start** and click **Control Panel**.
2. Click **Appearance** and **Personalization**.
3. Click **Personalization**.
4. Click **Display Settings**.
5. Click **Advanced Settings**.
6. Click **List All Modes**.
7. Select the one of the below selection at "**List All Modes**".

Display mode at "List All Modes"	HD Format
1920 by 1080, True Color (32bit), 60Hertz	1080p
1920 by 1080, True Color (32bit), 30Hertz (Interlaced)	1080i
1280 by 720, True Color (32bit), 60Hertz	720p
720 by 576, True Color (32bit), 50Hertz	576p
720 by 480, True Color (32bit), 60Hertz	480p



The above display mode is a typical HDMI display mode. The selectable display modes will vary for different HDMI monitors.

REGZA Link (PC Control)

HDMI out port can connect with Type A connector HDMI cable.

One HDMI cable can send and receive video, audio and control signals. HDMI-CEC (Consumer Electronics Control) is a standard in the CE Industry which allows devices to work together over an HDMI cable.

By connecting a TV player which supports HDMI Control to this port, the remote control for the connected TV can be used to operate some of the computer functions.



Some models are supported with the REGZA Link.

Using REGZA Link (PC Control)

Toshiba notebooks with REGZA Link include a Toshiba utility dedicated to take advantage of its capabilities which can allow you to:

- Use the TV remote control to output the computer screen onto the TV screen.
- Use the TV remote control to launch, operate and close applications on your computer.
- Turn on the TV when the HDMI output is selected using the Fn + F5 key.
- Switch the video output (HDMI or LCD) when executing certain desktop icons.
- Enable/Disable the REGZA Link function on the computer.

Television

A television can be connected to the video out port on the computer. To connect a television, follow the steps below.

1. Turn the computer off.
2. Use a video cable (not supplied) to connect the television to the video out port.

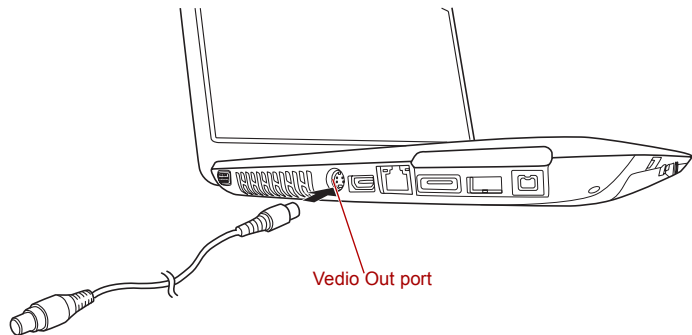

Figure 8-11 Connecting a television

3. Turn the television on.
4. Turn the computer on.

i.LINK (IEEE1394)

i.LINK (IEEE1394), is used for high-speed data transfer between a range of compatible devices such as:

- Digital video cameras
- Hard disk drives
- Magneto Optical drives
- Writable optical disc drives



i.LINK uses a four-pin connector which does not carry any electric current - therefore. External devices will need their own power supply in order to operate.

Precautions

- Make a back-up of your data before transferring it to the computer. There is a possibility that the original data will be damaged. There is a particular risk that some frames will be deleted in the case of digital video transfer. TOSHIBA assumes no liability for such loss of data.
- Do not transfer data in areas where static electricity is easily generated or in areas subjected to electronic noise. Data can be destroyed.
- If you are transferring data through an IEEE1394 hub, do not connect or disconnect other devices from the hub during data transfer. There is a likelihood that data will be damaged. Connect all devices to the hub before you turn on the computer's power.
- You may not use any copyrighted video or music data copied from a video camera except for your personal enjoyment.
- If you connect/disconnect an i.LINK device to/from another i.LINK device that is currently exchanging data with the computer, data frames might be dropped.
- Make sure data transfer has ended or turn off the computer, before you:
 - Connect/disconnect an i.LINK device to/from the computer.
 - Connect/disconnect an i.LINK device to/from another i.LINK device that is connected to the computer.

Connecting the i.LINK (IEEE1394) cable

To connect the i.LINK (IEEE1394) cable, follow the steps as detailed below:

1. Make sure the connectors are properly aligned and plug the i.LINK (IEEE1394) cable into the computer.

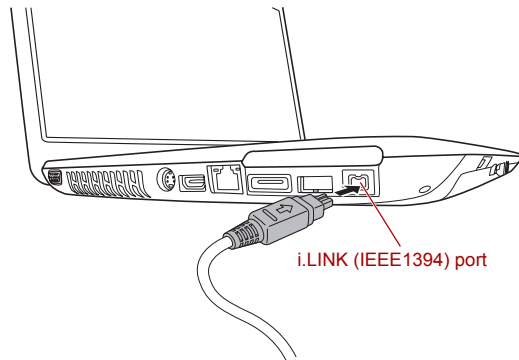

Figure 8-12 Connecting the i.LINK (IEEE1394) cable into the computer

2. Plug the other end of the cable into the device.

Note of the following when you use i.LINK:

- You may need to install drivers for your i.LINK devices.
- Not all i.LINK devices have been tested. Therefore, compatibility with all i.LINK devices cannot be guaranteed.
- Some devices might not support sleep or automatic off functions.
- Do not connect or disconnect an i.LINK device while it is using an application or when the computer is automatically shutting it down to save power. Data might be destroyed.

Disconnecting the i.LINK (IEEE1394) cable

To disconnect the i.LINK (IEEE1394) cable, follow the steps as detailed below:

1. Open the **Safely Remove Hardware** icon on the Windows Task Bar.
2. Point to i.LINK (IEEE1394) device and click.
3. Disconnect the cable from the computer then from the i.LINK device.



Refer also to the documentation that came with your i.LINK device

Security lock

A security locks enable you to anchor your computer a desk or other heavy object in order to help prevent unauthorized removal or theft. The computer has a security lock slot on its right side into which you can attach one end of the security cable, while the other end attaches to a desk or similar object. The methods used for attaching security cables differ from product to product. Please refer to the instructions for the product you are using for more information.

Connecting the security lock

In order to connect a security cable to the computer, follow the steps as detailed below:

1. Turn the computer so its left hand side faces you.
2. Align the security cable with the 'lock hole' and secure it in place.

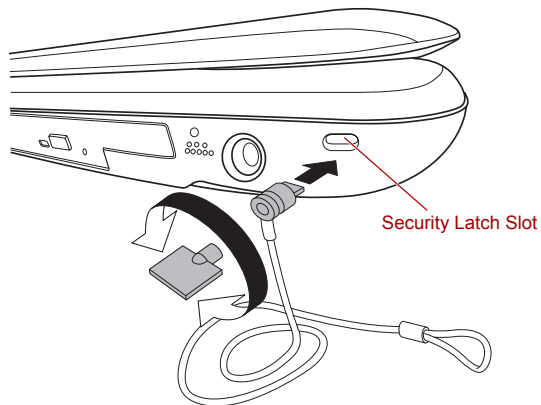

Figure 8-13 Security lock

Chapter 9

Troubleshooting

TOSHIBA have designed this computer for durability, however, should problems occur you are able to use the procedures detailed in this chapter to help determine the cause.

All users should become familiar with this chapter as knowing what might go wrong can help prevent problems from occurring in the first place.

Problem solving process

Resolving problems will be much easier if you observe the following guidelines:

- Stop immediately when you recognize a problem exists as taking further action may result in data loss or damage, or you may destroy valuable problem related information that can help solve the problem.
- Observe what is happening - write down what the system is doing and what actions you performed immediately before the problem occurred. If you have a printer attached, print a copy of the screen using the computer's **PRTSC** key.

Please also be aware that the questions and procedures described in this chapter are meant only as a guide, they are not definitive problem solving techniques. In reality many problems can be solved simply, but a few may require help from your reseller, dealer or service provider - if you find you need to consult others, be prepared to describe the problem in as much detail as possible.

Preliminary checklist

You should always consider the simplest solution first - the items detailed in this checklist are easy to fix and yet can cause what appears to be a serious problem:

- Make sure you turn on all peripheral devices before you turn on the computer - this includes your printer and any other external device you are using.
- Before you attach an external device you should first turn the computer off, then when you turn the computer back on again it will recognize the new device.
- Make sure all optional accessories are configured properly in the computer's setup program and that all required driver software has been loaded (please refer to the documentation included with the optional accessories for further information on its installation and configuration).
- Check all cables to ensure they are correctly and firmly attached to the computer - loose cables can cause signal errors.
- Inspect all connecting cables for loose wires and all connectors for loose pins.
- Check that your floppy diskette, CD or DVD media is correctly loaded and, in the case of a floppy diskette, that its write protect tab is correctly set.

Always try to make detailed notes of your observations and keep them in a permanent error log - this will help you to describe your problems to your reseller, dealer or service provider. In addition, if a problem recurs, the log you have made will help to identify the problem faster.

Analyzing the problem

Sometimes the computer will give you clues that can help you identify why it is malfunctioning. In view of this you should keep the following questions in mind:

- Which part of the computer is not operating properly - keyboard, hard disk drive, optical disc drive, display panel, touch pad, touch pad control buttons - as each device will produce different symptoms.
- Check the options within the operating system to ensure that its configuration is set properly.
- What appears on the display? Does it display any messages or random characters? If you have a printer attached, print a copy of the screen using the **PRINT** key and, if possible, look up the messages in the documentation included with the computer, software or operating system.
- Check that all connecting cables are correctly and firmly attached as loose cables can cause erroneous or intermittent signals.
- Do any indicators light, if so, which ones, what color are they and do they stay on or blink? Write down what you see.

- Do you hear any beeps, if so how many, are they long or short and are they high pitched or low pitched? In addition, is the computer making any unusual noises? Write down what you hear.

Record your observations so you can describe them in detail to your reseller, dealer or service provider.

Software The problems may be caused by your software or disk. If you cannot load a software package, the media may be damaged or the program might be corrupted - in these instances try loading another copy of the software if possible.

If an error message appears while you are using a software package you should refer to the documentation supplied with it as this will usually include a problem solving section or a summary of error messages.

Next, you should check any error messages against the operating system documentation.

Hardware If you cannot find a software problem, you should then check the setup and configuration of your hardware. First run through the items in the preliminary checklist as described previously then, if you still cannot correct the problem, try to identify the source - the next section provides checklists for individual components and peripherals.



Before using a peripheral device or application software that is not an authorized Toshiba part or product, make sure the device or software can be used with your computer. Use of incompatible devices may cause injury or may damage your computer.

Hardware and system checklist

This section discusses problems caused by your computer's hardware or attached peripherals. Basic problems may occur in the following areas:

- | | |
|--|--------------------------------|
| ■ System start-up | ■ Fingerprint Sensor |
| ■ Self test | ■ USB device |
| ■ Power | ■ eSATA device |
| ■ Password | ■ Memory expansion |
| ■ Keyboard | ■ Recovery Discs |
| ■ Internal display panel | ■ Sound system |
| ■ Hard disk drive | ■ External monitor |
| ■ USB floppy diskette drive | ■ Modem |
| ■ ExpressCard | ■ LAN |
| ■ SD/SDHC memory card, miniSD/microSD Card | ■ Wireless LAN |
| ■ Memory Stick/Memory Stick PRO/Memory Stick PRO Duo | ■ Bluetooth |
| ■ xD picture card | ■ TV output function |
| ■ MultiMediaCard | ■ HDMI monitor output function |
| ■ Infrared receiver window | ■ i.LINK (IEEE1394) device |
| ■ Pointing device | ■ Video Playback |
| | ■ FM tuner |

System start-up

When the computer does not start properly, check the following items:

- Self Test
- Power Sources
- Power-on Password

Self test

While booting up the computer, self test is executed automatically and the following will be displayed:

```
TOSHIBA Leading Innovation>>>
```

This message remains on the screen for a few seconds.

If the self test is successful, the computer tries to load the operating system according to how the **Boot Priority** option is set within the TOSHIBA HW Setup program.

If any of the following conditions are present, the self test has failed:

- The computer stops and does not proceed to display information or messages except for the TOSHIBA logo.
- Random characters appear on the screen and the system does not function normally.
- The screen displays an error message.

In these instances, turn off the computer, check all cable connections and then restart it - if the self test fails again, contact your reseller, dealer or service provider.

Power

When the computer is not plugged into an AC power outlet, the battery pack is the primary power source. However, your computer also has a number of other power resources, including an intelligent power supply and a Real Time Clock (RTC) battery, all of which are interrelated with any one having the ability to produce apparent power problems.

This section provides checklists for AC power and the battery. If you cannot resolve a problem after following them, the cause may lie with another power related resource - in such an instance you should contact your reseller, dealer or service provider.

Overheating power down

If the processor's temperature reaches an unacceptably high level with either setting, the computer will automatically shut down to prevent any damage - in this instance all unsaved data in memory will be lost.

Problem	Procedure
Computer shuts down and DC IN indicator blinks white	Leave the computer off until the DC IN indicator stops blinking.



*It is recommended to leave the computer off until the its interior reaches room temperature even though the **DC IN** indicator stops blinking.*

If the computer has reached room temperature and it still does not start, or if it starts but shuts down quickly, contact your reseller, dealer or service provider.

Computer shuts down and its DC IN indicator is flashing in white	This indicates a problem with the heat dispersal system - you should contact your reseller, dealer or service provider.
---	---

AC power

If you have trouble turning on the computer with the AC adaptor connected you should check the status of the **DC IN** indicator. Please refer to Chapter 6, [Power and Power-up Modes](#) for further information.

Problem	Procedure
AC adaptor doesn't power the computer (DC IN indicator does not glow white)	<p>Check the connections to make sure that the power cord/adaptor is firmly connected to the computer and a working power outlet.</p> <hr/> <p>Check the condition of the cord and terminals. If the cord is frayed or damaged it should be replaced, while if the terminals are soiled, they should be cleaned with a clean cotton cloth.</p> <hr/> <p>If the AC adaptor still does not power the computer, you should contact your reseller, dealer or service provider.</p>

Battery

If you suspect a problem with the battery, you should check the status of the **DC IN** indicator as well as the **Battery** indicator. Please refer to Chapter 6, *Power and Power-up Modes* for more information on these indicators, together with general battery operation.

Problem	Procedure
Battery doesn't power the computer	The battery may be discharged - connect the AC adaptor to recharge the battery.
Battery doesn't charge when the AC adaptor is attached (Battery indicator does not glow amber).	<p>If the battery is completely discharged, it will not begin charging immediately, in these instances you should wait a few minutes before trying again. If the battery still does not charge, you should check that the power outlet the AC adaptor is connected to is supplying power - this can be tested by plugging another appliance into it.</p> <p>Check whether the battery is hot or cold to the touch - if so, it will not charge properly and should be allowed to reach room temperature before you try again.</p> <p>Unplug the AC adaptor and remove the battery to make sure its connecting terminals are clean - if necessary wipe them with a soft dry cloth lightly dipped in alcohol.</p> <p>Connect the AC adaptor and replace the battery, taking care to ensure that it is securely seated in the computer.</p> <p>Check the Battery indicator - if it does not glow, allow the computer to charge the battery for at least twenty minutes. If the Battery indicator starts to glow after this period, allow the battery to continue to charge for at least another twenty minutes before turning on the computer.</p> <p>However, if the indicator still does not glow, the battery may be at the end of its operating life and should be replaced. However, if you do not believe the battery is at the end of its operating life, you should speak to your reseller, dealer or service provider.</p>
Battery doesn't power the computer as long as expected	<p>If you frequently recharge a partially charged battery, the battery might not charge to its full potential - in these instances you should fully discharge the battery and then attempt to charge it again.</p> <p>Check the Power saver option under Select a power plan in the Power Options.</p>

Real Time Clock

Problem	Procedure
<p>The following message is displayed on the LCD:</p> <p>RTC battery is low or CMOS checksum is inconsistent. Press [F2] key to set Date/Time.</p>	<p>The RTC battery charge has become exhausted, you should set the date and time in within the BIOS setup screen through the following steps:</p> <ol style="list-style-type: none"> 1. Press [F1] key. BIOS setup will boot up. 2. Press [F2] to set the date in [System Date]. 3. Press [F2] to set the time in [System Time].

Password

Problem	Procedure
<p>Cannot enter password</p>	<p>Please refer to the TOSHIBA Password Utility section in Chapter 6, Power and Power-up Modes for further information.</p>

Keyboard

Keyboard problems can be caused by the setup and configuration of the computer - please refer to Chapter 5, [The Keyboard](#) for further information.

Problem	Procedure
<p>Some letter keys produce numbers</p>	<p>Check that the numeric keypad overlay is not activated - press the FN + F11 hot key and try typing again.</p>
<p>Output to screen is garbled</p>	<p>Please refer to your software's documentation to ensure that its is not remapping the keyboard in any way (remapping involves changing or reassigning the function of each key).</p> <p>If you are still unable to use the keyboard, you should contact your reseller, dealer or service provider.</p>

Internal display panel

Apparent display panel problems may be related to the computer's setup and configuration - please refer to Chapter 7, *HW Setup and Passwords*, for further information.

Problem	Procedure
No display	Press the FN + F5 hot keys to adjust the display priority, and to make sure it is not set for output to an external monitor.
Markings appear on the LCD screen.	These marks may have come from contact with the keyboard, Touch Pad while the display has been closed. You should try to remove the marks by gently wiping the display panel with a clean dry cloth or, if this fails, with a good quality LCD screen cleaner. In this latter instance you should always follow the instructions with the screen cleaner and always ensure you let the LCD screen dry properly before closing it.
Problems above remain unresolved or other problems occur	You should initially refer to the documentation supplied with you software to determine if it is this that is causing the problems. Alternatively you may wish to run the TOSHIBA PC Diagnostic Tool to check the general operation of the computer. If you are still unable to resolve the problem, contact your reseller, dealer or service provider.

Hard disk drive

Problem	Procedure
Computer does not boot from hard disk drive	<p>Check to see whether that is a floppy diskette in the floppy diskette drive or a CD-ROM/DVD-ROM in the optical disc drive - if so remove it and try to start the computer again.</p> <p>If this has no effect, check the Boot Priority setting within the TOSHIBA HW Setup utility - please refer to the <i>Boot Priority</i> section in Chapter 7, <i>HW Setup and Passwords</i> for further information.</p> <p>Please refer to your operating system documentation in order to determine whether there is a problem with any of the operating system files or settings.</p>

Problem	Procedure
Slow performance	<p>The files on the hard disk drive may be fragmented - in this instance you should run the disk Defragmentation utility to check the condition of your files and the hard disk drive. Please refer to the operating system's documentation or online Help File for further information on operating and using the Defragmentation utility.</p> <hr/> <p>As a last resort you should reformat the hard disk drive and then reload the operating system and all other files and data. If you are still unable to resolve the problem, contact your reseller, dealer or service provider.</p>

DVD Super Multi drive

For further information, please refer to Chapter 4, [Operating Basics](#).

Problem	Procedure
You cannot access a CD/DVD in the drive	<p>Make sure the drive's disc tray is securely closed - press it gently into the computer until it clicks into place.</p> <hr/> <p>Open the drive's disc tray and ensure the CD or DVD is properly seated - it should lie flat with the label facing upwards.</p> <hr/> <p>A foreign object in the drive's disc slot could block laser light from reading the CD or DVD - remove any foreign objects or obstructions that may be present.</p> <hr/> <p>Check whether the CD or DVD is dirty - if it is, wipe it with a clean cloth lightly dipped in water or a neutral cleaner. Please refer to the Media care section in Chapter 4 for further details on cleaning the media.</p>

Problem	Procedure
Some CD/DVD/DVDs run correctly, but others do not	The computer's software or hardware configuration may be causing a problem - ensure that these configurations match the requirements of the CD/DVD media (refer to the CD's or DVD's documentation if available).
	<p>Check the type of CD or DVD media that you are using - the drive supports the following:</p> <p>DVD: DVD-ROM, DVD-Video</p> <p>CD: CD-DA, CD-Text, Photo CD™ (single/multi-session), CD-ROM Mode 1, Mode 2, CD-ROM XA Mode 2 (Form1, Form2), Enhanced CD (CD-EXTRA), Addressing Method 2</p>

USB floppy diskette drive

The USB floppy diskette drive is available only as an option. For further information, please refer to Chapter 4, [Operating Basics](#).

Problem	Procedure
Drive does not operate	Check the connection between the computer and the drive to ensure that it is properly attached.
Some programs run correctly but others do not	The computer's software or hardware configuration may be causing a problem - ensure that these configurations match your requirements (refer to any relevant documentation, for example that supplied with any software in use, for further information).
You cannot access the external floppy diskette drive	<p>Try another floppy diskette in the drive - if you are able to access this disk then it indicates the original disk and not the drive is probably causing the problem.</p> <p>If you are still unable to resolve the problem, contact your reseller, dealer or service provider.</p>

ExpressCard

For further information, please refer to Chapter 8, *Optional Devices*.

Problem	Procedure
ExpressCard error occurs	<p>Remove the ExpressCard from the computer and then reinsert it in order to ensure it is firmly connected.</p> <hr/> <p>In the event that the ExpressCard is attached to an external peripheral device, ensure that this connection is properly made.</p> <hr/> <p>If the problem persists, then you should refer to the documentation supplied with your ExpressCard for further information.</p> <p>If you are still unable to resolve the problem, contact your reseller, dealer or service provider.</p>

SD/SDHC memory card, miniSD/microSD Card

For further information, please refer to Chapter 8, *Optional Devices*.

Problem	Procedure
SD/SDHC memory card, miniSD/microSD Card error occurs	<p>Remove the SD/SDHC memory card, miniSD/microSD Card from the computer and then reinsert it in order to ensure it is firmly connected.</p> <p>If the problem persists, then you should refer to the documentation supplied with your SD/SDHC memory card, miniSD/microSD Card for further information.</p>
You cannot write to an SD/SDHC memory card	<p>Remove the SD/SDHC memory card from the computer and check to ensure that it is not write protected.</p>
You cannot read a file	<p>Check to ensure the required file is actually on the SD/SDHC memory card, miniSD/microSD Card that is inserted into the computer.</p> <p>If you are still unable to resolve the problem, contact your reseller, dealer or service provider.</p>

Memory Stick/Memory Stick PRO/Memory Stick PRO Duo

For further information, please refer to Chapter 8, [Optional Devices](#).

Problem	Procedure
Memory Stick/Memory Stick PRO/Memory Stick PRO Duo error occurs	Remove the Memory Stick/Memory Stick PRO/Memory Stick PRO Duo from the computer and then reinsert it in order to ensure it is firmly connected. If the problem persists, then you should refer to the documentation supplied with your Memory Stick/Memory Stick PRO/Memory Stick PRO Duo for further information.
You cannot write to an Memory Stick/Memory Stick PRO	Remove the Memory Stick/Memory Stick PRO from the computer and check to ensure that it is not write protected.
You cannot read a file	Check to ensure the required file is actually on the Memory Stick/Memory Stick PRO/Memory Stick PRO Duo that is inserted into the computer. If you are still unable to resolve the problem, contact your reseller, dealer or service provider.

xD picture card

For further information, please refer to Chapter 8, [Optional Devices](#).

Problem	Procedure
xD picture card error occurs	Remove the xD picture card from the computer and then reinsert it in order to ensure it is firmly connected. If the problem persists, then you should refer to the documentation supplied with your xD picture card for further information.
You cannot read a file	Check to ensure the required file is actually on the xD picture card that is inserted into the computer. If you are still unable to resolve the problem, contact your reseller, dealer or service provider.

MultiMediaCard

For further information, please refer to Chapter 8, *Optional Devices*.

Problem	Procedure
MultiMediaCard error occurs	Remove the MultiMediaCard from the computer and then reinsert it in order to ensure it is firmly connected. If the problem persists, then you should refer to the documentation supplied with your MultiMediaCard for further information.
You cannot read a file	Check to ensure the required file is actually on the MultiMediaCard that is inserted into the computer. If you are still unable to resolve the problem, contact your reseller, dealer or service provider.

Infrared receiver window

If you are using a USB mouse, you should also refer to both the *USB device* section in this chapter, and the documentation supplied with your mouse.

Problem	Procedure
Infrared devices do not work as expected	Make sure there is no obstruction blocking communication between the computer and the target device. If you are still unable to resolve the problem, contact your reseller, dealer or service provider.

Pointing device

If you are using a USB mouse, you should also refer to both the *USB device* section in this chapter, and the documentation supplied with your mouse.

Touch Pad

Problem	Procedure
On-screen pointer does not respond to pointing device operation	In this instance the system might be busy - Try moving the mouse again after waiting a short while.

Problem	Procedure
Double-tapping does not work	<p>In this instance, you should initially try changing the double-click speed setting within the Mouse Control utility.</p> <ol style="list-style-type: none"><li data-bbox="518 248 1047 328">1. To access this utility, click Start -> Control Panel -> Hardware and Sound -> Mouse icon.<li data-bbox="518 336 1047 389">2. Within the Mouse Properties window, click the Buttons tab.<li data-bbox="518 397 1047 448">3. Set the double-click speed as required and click OK.
The mouse pointer moves too fast or too slow	<p>In this instance, you should initially try changing the speed setting within the Mouse Control utility.</p> <ol style="list-style-type: none"><li data-bbox="518 528 1047 608">1. To access this utility, click Start -> Control Panel -> Hardware and Sound -> Mouse icon.<li data-bbox="518 616 1047 668">2. Within the Mouse Properties window, click the Pointer Options tab.<li data-bbox="518 676 1047 729">3. Set the pointer speed as required and click OK. <p>If you are still unable to resolve the problem, contact your reseller, dealer or service provider.</p>
The reaction of Touch pad is either too sensitive or not sensitive enough.	<p>Adjust the touch Sensitivity.</p> <ol style="list-style-type: none"><li data-bbox="518 850 1047 903">1. Click Start -> Control Panel -> Hardware and Sound -> Mouse icon.<li data-bbox="518 911 1047 963">2. Within the Mouse Properties window, click the Device Settings tab.<li data-bbox="518 971 1047 999">3. Click the Settings button.<li data-bbox="518 1007 1047 1059">4. Properties for Synaptics TouchPad V6.3 on PS/2 Port window is displayed.<li data-bbox="518 1067 1047 1120">5. Select Sensitivity from the Select an item list.<li data-bbox="518 1128 1047 1181">6. Select Touch Sensitivity and move the slider bar to adjust the sensitivity.<li data-bbox="518 1189 1047 1217">7. Click the OK button.

USB mouse

Problem	Procedure
On-screen pointer does not respond to mouse operation	<p>In this instance the system might be busy - Try moving the mouse again after waiting a short while.</p> <hr/> <p>Remove the mouse from the computer and then reconnect it to a free USB port it in order to ensure it is firmly attached.</p> <hr/>
Double-clicking does not work	<p>In this instance, you should initially try changing the double-click speed setting within the Mouse Control utility.</p> <ol style="list-style-type: none">1. To access this utility, click Start -> Control Panel -> Hardware and Sound -> Mouse icon.2. Within the Mouse Properties window, click the Buttons tab.3. Set the double-click speed as required and click OK. <hr/>
The mouse pointer moves too fast or too slow	<p>In this instance, you should initially try changing the speed setting within the Mouse Control utility.</p> <ol style="list-style-type: none">1. To access this utility, click Start -> Control Panel -> Hardware and Sound -> Mouse icon.2. Within the Mouse Properties window, click the Pointer Options tab.3. Set the pointer speed as required and click OK. <hr/>
The mouse pointer moves erratically	<p>The elements of the mouse responsible for detecting movement might be dirty - please refer to the documentation supplied with the mouse for instructions on how to clean it.</p> <p>If you are still unable to resolve the problem, contact your reseller, dealer or service provider.</p> <hr/>

Fingerprint Sensor

Problem	Procedure
Reading of the fingerprint was not successful.	<p>In this instance you should try the fingerprint reading operation again using the correct finger position - please refer to Using the Fingerprint Sensor in Chapter 4, Operating Basics for further information.</p> <p>Alternatively, you should try the recognition process again using another enrolled finger. The fingerprint sensor compares and analyzes the unique characteristics in a fingerprint. However, there may be instances where certain users are unable to register their fingerprints due to insufficient unique characteristics in their fingerprints. The recognition success rate may differ from user to user.</p>
The fingerprint cannot be read due to injuries to the finger.	<p>In this instance you should try the recognition process again using another enrolled finger. However, if fingerprints from all the enrolled fingers cannot be read, you should instead log into the computer by using the keyboard to input the password.</p> <p>If you are still unable to resolve the problem, contact your reseller, dealer or service provider.</p>

USB device

In addition to the information in this section, please also refer to the documentation supplied with your USB device.

Problem	Procedure
USB device does not work	<p>Remove the USB device from the computer and then reconnect it to a free port it in order to ensure it is firmly attached.</p> <p>Ensure that any required USB device drivers are properly installed - to achieve this you should refer to both the device documentation and the operating system documentation.</p> <p>If you are using an operating system that does not support USB, you are still able to use a USB mouse and/or USB keyboard by setting the USB KB/Mouse Emulation option within the TOSHIBA HW Setup utility to Enabled.</p> <p>If you are still unable to resolve the problem, contact your reseller, dealer or service provider.</p>

USB Sleep and Charge function

For more information and settings, please refer to the USB Sleep and Charge function section in Chapter 7, *HW Setup and Passwords*.

Problem	Procedure
I cannot use the "USB Sleep and Charge function".	<p>The setting of "USB Sleep and Charge function" may be [Disabled]. Change the setting to [Enabled].</p> <hr/> <p>When there is a current overflow of the external device connected to the compatible port, USB bus power (DC5V) supply may be stopped for safety reasons. When this happens, disconnect an external device if some external devices are connected. After that, turn the power of the computer ON/OFF to restore the function. If this function can not be still used even if only one external device is connected, stop using the external device because its current is over the acceptable value of this computer.</p> <hr/> <p>Some external devices may not be able to use the "USB Sleep and Charge function". In this case, please try one or more of the following methods.</p> <ul style="list-style-type: none"> ■ Change a mode setting of [Enabled]. ■ Turn OFF the computer while external devices are connected. ■ Connect external devices after turning OFF of the computer. <p>If this function can not be still used, change the setting to [Disabled] and stop using this function.</p>
The battery depletes quickly even when I turned OFF the power of the computer.	<p>When "USB Sleep and Charge function" is set to [Enabled], USB bus power (DC5V) will be supplied to the external device connected to the compatible port. If external device is connected to the compatible port when the AC adaptor is not connected to the computer, the battery of the computer will be depleted even when the power of the computer is turned OFF.</p> <p>Connect the AC adaptor to the computer or change the "USB Sleep and Charge function" setting to [Disabled].</p> <p>Instead use an USB port that does not have the USB Sleep and Charge function-compatible icon (⚡).</p>

Problem	Procedure
<p>External devices connected to the compatible ports do not work when connected to a compatible port.</p>	<p>Some external devices may not work when connected to a compatible port when the "USB Sleep and Charge function" is [Enabled].</p> <p>Reconnect the external device after turning ON the computer.</p> <p>If the external device still does not work, connect device to an USB port that does not have the USB Sleep and Charge function-compatible icon (⚡) or change the "USB Sleep and Charge function" setting to [Disabled].</p>
<p>The "USB WakeUp function" does not work.</p>	<p>When "USB Sleep and Charge function" is set to [Enabled], the "USB WakeUp function" does not work for ports that support the USB Sleep and Charge function.</p> <p>In that case, use an USB port that does not have the USB Sleep and Charge function-compatible icon (⚡) or change the "USB Sleep and Charge function" setting to [Disabled].</p>

eSATA device

In addition to the information in this section, please also refer to the documentation supplied with your [eSATA device](#).

Problem	Procedure
<p>eSATA device does not work</p>	<p>Remove the eSATA device from the computer and then reconnect it to a free port it in order to ensure it is firmly attached.</p> <p>A connected eSATA device may not be recognized if it is connected to the computer's eSATA/USB combo port while the computer is in Sleep Mode or Hibernation Mode. If this occurs, disconnect the eSATA device and then reconnect the device while the computer is turned on.</p> <p>Ensure that any required eSATA device drivers are properly installed - to achieve this you should refer to both the device documentation and the operating system documentation.</p> <p>If you are still unable to resolve the problem, contact your reseller, dealer or service provider.</p>

Additional memory module

Please also refer to Chapter 8, *Optional Devices*, for further information on installing and removing memory modules.

Problem	Procedure
<p>If there is a memory malfunction, the Power indicator will repeatedly flash (on for 0.5 seconds, off for 0.5 seconds) in the following patterns;</p> <p>If there is an error in only slot A or no memory module is inserted in Slot A: amber twice, then green once.</p> <p>If there is an error in Slot B: amber once, then green twice.</p> <p>If there are errors in both Slot A and Slot B: amber twice, then green twice.</p>	<p>In the event of Power indicator flashes when the computer is turned on you should initially ensure that the installed memory module(s) are compatible with the computer. If you determine that an incompatible module has been installed, you should follow the steps as detailed below:</p> <ol style="list-style-type: none"> 1. Turn off the computer. 2. Disconnect the AC adaptor and all peripheral devices. 3. Remove the battery pack. 4. Remove the incompatible memory module. 5. Install the battery and/or connect the AC adaptor. 6. Turn on the computer. <p>If you are still unable to resolve the problem, contact your reseller, dealer or service provider.</p>
<p>An error will occur if a memory module is inserted into Slot B while no memory module is inserted in Slot A.</p>	<p>Remove the memory module from Slot B and insert it into Slot A.</p>

Sound system

In addition to the information in this section, please also refer to the documentation supplied with your audio device.

Problem	Procedure
<p>No sound is heard</p>	<p>Adjust the volume control.</p> <p>Turn the dial clockwise to increase the volume and turn it counter-clockwise to decrease the volume.</p> <hr/> <p>Check the software volume settings.</p> <hr/> <p>Please check to see if Mute is turned to Off.</p> <hr/> <p>Check to make sure the headphone connection is secure.</p>

Problem	Procedure
	<p>Check within the Windows Device Manager application to ensure the sound function is enabled.</p> <p>If you are still unable to resolve the problem, contact your reseller, dealer or service provider.</p>
<p>Annoying sound is heard</p>	<p>In this instance you may be experiencing feedback from either the internal microphone or an external microphone connected to the computer - please refer to Sound system in Chapter 4, Operating Basics for further information.</p> <p>Volume cannot be adjusted when Windows is turned on or turned off.</p> <p>If you are still unable to resolve the problem, contact your reseller, dealer or service provider.</p>

Volume control

Problem	Procedure
<p>No sound is heard</p>	<p>Adjust the volume control.</p> <p>Turn the dial clockwise to increase the volume and turn it counter-clockwise to decrease the volume.</p> <p>Turn the volume control while verifying the volume in order to adjust.</p>
<p>Annoying sound is heard</p>	<p>Volume cannot be adjusted when Windows is turned on or turned off.</p> <p>If you are still unable to resolve the problem, contact your reseller, dealer or service provider.</p>

External monitor

Please also refer to Chapter 8, [Optional Devices](#), and to the documentation supplied with your monitor for further information.

Problem	Procedure
<p>Monitor does not turn on</p>	<p>After confirming that the monitor's power switch is on, you should check the connections to make sure that the power cord/adaptor is firmly connected to the monitor and to a working power outlet.</p>

Problem	Procedure
No display	<p>Try adjusting the contrast and brightness controls on the external monitor.</p> <hr/> <p>Press the FN + F5 hot key in order to change the display priority and ensure that it is not set for the internal display panel only.</p> <hr/> <p>Check to see if the external monitor is connected. When the external monitor is set as the primary display device in extended desktop mode, it will not display when the computer wakes up from Sleep Mode if the external monitor has been disconnected while in Sleep Mode.</p> <p>To keep this from happening, do not disconnect the external monitor while the computer is in Sleep or Hibernation Mode.</p> <p>Remember to turn off the computer before disconnecting the external monitor.</p> <hr/> <p>When the display panel and an external monitor are set to clone mode and the monitors are turned off by the timer, the display panel or the external monitor may not display when turned on again.</p> <p>If this occurs, press FN + F5 to re-set the display panel and external monitor to clone mode.</p>
Display error occurs	<p>Check that the cable connecting the external monitor to the computer is firmly attached.</p> <p>If you are still unable to resolve the problem, contact your reseller, dealer or service provider.</p>

Modem



This information is applicable to the models equipped with a built-in modem.

Problem	Procedure
Communication software can't initialize modem	<p>Make sure the computer's internal modem settings are correct - please refer to the Phone and Modem Options link within the Windows Control Panel.</p>
You can hear a dial tone but can't make a call	<p>If the call is going through a Private Branch Exchange (PBX), take care to ensure that the communication application's tone dial detection feature is disabled.</p>

Problem	Procedure
You place a call, but a connection can't be made	Make sure that the settings are correct within your communication application.
After making a call you can't hear a ring	Ensure that the communication application's tone or pulse dialling selection feature is set correctly.
Communication is cut off unexpectedly	The computer will automatically cut off communication when connection with the carrier is not successful for a set time interval - try lengthening this time interval within your communication application.
A CONNECT display is quickly replaced by NO CARRIER	Ensure that the communication application's error control feature is set correctly.
Character display becomes garbled during a communication	When transmitting data you should ensure that the parity bit and stop bit settings correspond with those of the remote computer - you should check the flow control and communication protocol settings within your communication application.
You cannot receive an incoming call	Ensure that the communication application's rings before auto answer feature is set correctly. If you are still unable to resolve the problem, contact your reseller, dealer or service provider.

LAN

Problem	Procedure
Cannot access LAN	Check for a firm cable connection between the LAN jack and the LAN HUB.
Wake-up on LAN does not work	Make sure the AC adaptor is connected. The Wake-up on LAN function consumes power even when the system is off. If problems persist, consult your LAN administrator.

Wireless LAN

If the following procedures do not restore LAN access, consult your LAN administrator. For more information on wireless communication, refer to Chapter 4, *Operating Basics*.

Problem	Procedure
Cannot access Wireless LAN	Make sure the computer's wireless communication switch is set to on.

Bluetooth

For further information on Bluetooth wireless communication, please refer to Chapter 4, *Operating Basics*.

Problem	Procedure
Cannot access Bluetooth device	<p>Check to ensure the computer's wireless communication switch is set to on.</p> <hr/> <p>Check to ensure the Bluetooth Manager application is running on the computer and that power to the external Bluetooth device is turned on.</p> <hr/> <p>Check to ensure that no optional Bluetooth Adaptor is installed in the computer - the built-in Bluetooth hardware cannot operate simultaneously with another Bluetooth controller. If you are still unable to resolve the problem, contact your reseller, dealer or service provider.</p>

HDMI monitor output function

Problem	Procedure
No display	<p>Try adjusting the contrast and brightness controls on the television.</p> <hr/> <p>Press the FN + F5 hot key in order to change the display priority and ensure that it is not set for the internal display panel only.</p> <p>If you are still unable to resolve the problem, contact your reseller, dealer or service provider.</p>



If you turn the computer off into Sleep Mode while the display is on TV, the computer will select either the internal LCD or an external computer CRT as the display device the next time is switched on.

i.LINK (IEEE1394) device

Problem	Procedure
i.LINK device does not function	<p>Check that the cable connecting the external device to the computer is firmly attached.</p> <hr/> <p>Check to ensure that power is being supplied to the device and that the device is turned on.</p> <hr/> <p>Reinstall the drivers required for the device - this can be achieved by clicking Start, Control Panel, Hardware and Sound and then clicking the Add Hardware icon at the left-hand side of the screen and following the on-screen instructions.</p> <hr/> <p>Restart the computer and the Windows operating system to re-initialize the device.</p> <p>If you are still unable to resolve the problem, contact your reseller, dealer or service provider.</p>

Video Playback

Problem	Procedure
DVD does not play smoothly when using the Windows Media Center of the DVD playing software	<p>Try setting the configuration in the BIOS setup. However, note that when the BIOS setup configuration is modified, the power saving function of PCI Express becomes disabled. Refer to Chapter 7, <i>HW Setup and Passwords</i> for more information.</p> <p>Set the PCI Express Link ASPM in the BIOS setup using the following steps:</p> <ol style="list-style-type: none"> 1. Press the F1 key. The BIOS setup screen will appear. 2. Set the PCI Express Link ASPM to Disabled in BATTERY. 3. Press the END key. A confirmation message will appear. 4. Press the Y key. The BIOS setup will terminate and the computer will reboot. <p>If you are still unable to resolve the problem, contact your reseller, dealer or service provider.</p>

FM tuner



The computer is equipped with either a modem jack or FM tuner jack.

Problem	Procedure
Poor reception	<p>Adjust the FM tuner antenna.</p> <p>Make sure the FM tuner antenna connection is secure.</p> <p>If you are still unable to resolve the problem, contact your reseller, dealer or service provider.</p>

TOSHIBA support

If you require any additional help using your computer or if you are having problems operating the computer, you may need to contact TOSHIBA for additional technical assistance.

Before you call

Some problems you experience may be related to software or the operating system so it is important that you investigate other sources of assistance first. Before contacting TOSHIBA, try the following:

- Review troubleshooting sections in the documentation supplied with your software and/or peripheral devices.
- If a problem occurs when you are running software applications, consult the software documentation for troubleshooting suggestions and consider calling the software company's technical support department for assistance.
- Consult the reseller or dealer from where you purchased your computer and/or software - they are your best resource for current information and support.

Where to write

If you are still unable to solve the problem and suspect that it is hardware related, write to TOSHIBA at the nearest location listed below:

Outside of Europe	In Europe
<p>Australia TOSHIBA Australia Pty. Ltd. Information Systems Division 84-92 Talavera Road North Ryde N.S.W. 2113 Sydney</p>	<p>Germany & Austria TOSHIBA Europe (I.E.) GmbH Geschäftsbereich, Deutschland-Österreich Hammfelddamm 8, D-41460 Neuss, Germany</p>
<p>Canada TOSHIBA of Canada Ltd. 191 McNabb Street, Markham, Ontario L3R 8H2</p>	<p>France TOSHIBA Systèmes France S.A. 7, Rue Ampère B.P. 131, 92804 Puteaux Cedex</p>
<p>China TOSHIBA Personal Computer & Network (Shanghai) Co., Ltd. 43F, Hong Kong New World Tower, No. 300 Huaihai Zhong Road, Shanghai, P. R. China 200021</p>	<p>Netherlands TOSHIBA Information Systems, Benelux B.V. Rivium Boulevard 41 2909 LK Capelle a/d IJssel</p>
<p>Singapore TOSHIBA Singapore Pte. Ltd. 438B Alexandra Road #06-01 Alexandra Technopark Singapore 119968</p>	<p>Spain TOSHIBA Information Systems, ESPAÑA Parque Empresarial San Fernando Edificio Europa, 1ª Planta, Escalera A 28830 Madrid</p>
<p>United States of America TOSHIBA America Information Systems, Inc. 9740 Irvine Boulevard Irvine, California 92618 USA</p>	<p>United Kingdom TOSHIBA Information Systems (U.K.) Ltd. TOSHIBA Court Weybridge Business Park Addlestone Road Weybridge, Surrey KT15 2UL</p>
<p>India Toshiba India Pvt Ltd. PC Division 6th Floor, DR Gopal Das Bhawan Barakhamba Road, Delhi-110001, India</p>	<p>The Rest of Europe TOSHIBA Europe (I.E.) GmbH Geschäftsbereich, Deutschland- Österreich Hammfelddamm 8, D-41460 Neuss, Germany</p>

Chapter 10

Disclaimers

This chapter states the Disclaimer(s) information applicable to TOSHIBA computers.

CPU

Central Processing Unit ("CPU") Performance Disclaimer.

CPU performance in your computer product may vary from specifications under the following conditions:

- use of certain external peripheral products
- use if battery power instead of AC power
- use of certain multimedia, computer generated graphics or video applications
- use of standard telephone lines or low speed network connections
- use of complex modeling software, such as high end computer aided design applications
- use of several applications or functionalities simultaneously
- use of computer in areas with low air pressure (high altitude >1,000 meters or >3,280 feet above sea level)
- use of computer at temperatures outside the range of 5°C to 35°C (41°F to 95°F) or >25°C (77°F) at high altitude (all temperature references are approximate and may vary depending on the specific computer model - please refer to your computer documentation or visit the Toshiba website at www.pcsupport.toshiba.com for details).

CPU performance may also vary from specifications due to design configuration.

Under some conditions, your computer product may automatically shut-down. This is a normal protective feature designed to reduce the risk of lost data or damage to the product when used outside recommended conditions. To avoid risk of lost data, always make back-up copies of data by periodically storing it on an external storage medium. For optimum performance, use your computer product only under recommended conditions. Read additional restrictions under "Environmental Conditions" in your computer documentation.

Contact Toshiba Technical Service and Support for more information.

64-Bit Computing

64-bit processors are designed to take advantage of 32 and 64 bit computing.

64-bit computing requires that the following hardware and software requirements are met:

- 64-bit Operating System
- 64-bit CPU, Chipset and BIOS (Basic Input/Output System)
- 64-bit Device drivers
- 64-bit applications

Certain device drivers and/or applications may not be compatible with a 64-bit CPU and therefore may not function properly. A 32-bit version of the operating system is preinstalled on your computer unless explicitly stated that the operating system is 64-bit.

Memory (Main System)

Part of the main system memory may be used by the graphics system for graphics performance and therefore reduce the amount of main system memory available for other computing activities. The amount of main system memory allocated to support graphics may vary depending on the graphics system, applications utilized, system memory size and other factors. Computers configured with a 32-bit operating system can address up to 3GB of system memory. Only computers configured with a 64-bit operating system can address 4GB or more of system memory.

Battery Life

Battery life may vary considerably depending on product model, configuration, applications, power management settings and features utilized, as well as the natural performance variations produced by the design of individual components. Published battery life numbers are achieved on select models and configurations tested by Toshiba at the time of publication. Recharge time varies depending on usage. Battery may not charge while computer is consuming full power.

After a period of time, the battery will lose its ability to perform at maximum capacity and will need to be replaced. This is normal for all batteries. To purchase a new battery pack, see the accessories information that shipped with your computer.

HDD drive capacity

One Gigabyte (GB) means $10^9 = 1,000,000,000$ bytes using powers of 10. The computer operating system, however, reports storage capacity using powers of 2 for the definition of $1 \text{ GB} = 2^{30} = 1,073,741,824$ bytes, and therefore shows less storage capacity. Available storage capacity will also be less if the product includes one or more pre-installed operating systems, such as Microsoft Operating System and/or pre-installed software applications, or media content. Actual formatted capacity may vary.

LCD

Over a period of time, and depending on the usage of the computer, the brightness of the LCD screen will deteriorate. This is an intrinsic characteristic of LCD technology.

Maximum brightness is only available when operating in AC power mode. Screen will dim when the computer is operated on battery power and you will not be able to increase the brightness of the screen.

Graphics Processor Unit ("GPU")

Graphics processor unit ("GPU") performance may vary depending on product model, design configuration, applications, power management settings and features utilized. GPU performance is only optimized when operating in AC power mode and may decrease considerably when operating in battery power mode.

Wireless LAN

The transmission speed over the wireless LAN and the distance over which wireless LAN can reach may vary depending on surrounding electromagnetic environment, obstacles, access point design and configuration, and client design and software/hardware configurations.

The actual transmission speed will be lower than the theoretical maximum speed. New wireless network adapter "AR9281" supports IEEE802.11b/g/draft-n but does not support IEEE802.11a. The wireless adapter is based on a draft 2.0 release version of the IEEE 802.11n specification and; may not be full compatible with, or support some feature (e.g., security) of, certain Wi-Fi equipment.

USB Sleep & Charge

The "USB Sleep & Charge function" may not work with certain external device even if they are compliant with the USB specification. In those cases, turn the power of the computer ON to charge the device.

External HDD Capacity

One Gigabyte (GB) means $10^9 = 1,000,000,000$ bytes using powers of 10. A computer operating system, however, reports storage capacity using powers of 2 for the definition of $1\text{GB} = 2^{30} = 1,073,741,824$ bytes, and therefore shows less storage capacity. Available storage capacity will also be less if the computer includes one or more pre-installed operating systems, pre-installed software applications, or media content. Actual formatted capacity may vary.

Non-applicable Icons

Certain notebook chassis are designed to accommodate all possible configurations for an entire product series. Your selected model may not have all the features and specifications corresponding to all of the icons or switches shown on the notebook chassis, unless you have selected all those features.

Copy Protection

Applicable copy protection standards included in certain media may prevent or limit recording or viewing of the media.

Images

All images are simulated for purposes of illustration.

LCD Brightness and Eye Stain

Your display panel has a brightness approaching that of a TV device. We recommend that you adjust the brightness of your LCD to a comfortable level to prevent possible strain on your eyes.

Specifications 1

Appendix A

Display Controller 1

Appendix B

V.90/V.92 1

Appendix C

Wireless LAN 1

Appendix D

AC Power Cord and Connectors 1

Appendix E

Appendix A

Specifications

This appendix summarizes the computer's technical specifications.

Environmental requirements

	Operating	Non-operating
Ambient temperature	5°C to 35°C	-20°C to 60°C
Relative humidity	20% to 80%	10% to 90%
Altitude (from sea level)	-30 to 3,000 meters	-30 to 10,000 meters

Power Requirements

AC adaptor	100-240 volts AC 50 or 60 hertz (cycles per second)
Computer	19V DC

Built-in Modem

The ability of this feature is depending on the model you purchased.

Network control unit (NCU)	
Type of NCU	AA
Type of line	Telephone line (analog only)
Type of dialing	Pulse Tone
Control command	AT commands EIA-578 commands
Monitor function	Computer's speaker
Communication specifications	
Communication system	Data: Full duplex Fax: Half duplex
Communication protocol	Data ITU-T-Rec (Former CCITT) V.21/V.22/V.22bis/V.32/V.32 bis/V.34/V.90 Bell 103/212A Fax ITU-T-Rec (Former CCITT) V.17/V.29/V.27ter/V.21 ch2
Communication speed	Data transmission and reception 300/1200/2400/4800/7200/9600/12000/14400/16800/19200/21600/24000/26400/28800/31200/33600 bps Data reception only with V.90 28000/29333/30666/32000/33333/34666/36000/37333/38666/40000/41333/42666/44000/45333/46666/48000/49333/50666/52000/53333/54666/56000 bps Fax 2400/4800/7200/9600/12000/14400 bps
Error correcting	MNP class 4 and ITU-T V.42
Data compression	MNP class 5 and ITU-T V.42bis

Appendix B

Display Controller

Display controller

The display controller interprets software commands into hardware commands that turn particular pixels on or off.

The controller is an advanced Video Graphics Array (VGA) that provides Super VGA (SVGA) and Extended Graphics Array (XGA) support for the internal LCD and external monitors.

A high-resolution external monitor connected to the computer can display up to 2048 horizontal and 1536 vertical pixels at up to 16M colors.

The display controller also controls the video mode, which uses industry standard rules to govern the screen resolution and the maximum number of colors that can be displayed on screen.

Software written for a given video mode will run on any computer that supports the mode.

The computer's display controller supports all SVGA and XGA modes, the most widely used industry standards.



Some of display modes might not be supported depending on the external monitor which you use.



If you are running some application (for example a 3D application or video playback and so on), you may use some disturbance, flickering or frame dropping on your screen. If that occurs, adjust the resolution of display, lowering it until the screen is displayed properly. You could also disable Windows Aero™ to help correct this situation.

Appendix C

V.90/V.92

The TOSHIBA internal modem uses V.90 technology. The modem is capable of downstream speeds of 56Kbps (kilobits per second) when connected to an Internet service provider that supports V.90/V.92. As with any modem, the actual throughput (speed of data transfer) depends on analog telephone line conditions, which can vary considerably. Therefore, many users will experience throughput in the range of 32-44Kbps under normal telephone line conditions. Upstream data flows at the V.34 rate.



V.90 rates can be achieved only when one V.90 capable modem is connected to another. The TOSHIBA Internal modem will select automatically V.34 if the remote modem lacks V.90 capability or if a combination of network and/or phone line conditions prevent V.90 connection.

V.90/V.92 mode

Function	Transmission speed
Data V.90/V.92	From 56K (maximum) to 28Kbps (minimum) Reception only

Table Result codes for a V.90 connection

No.	Result code	Description
70	CONNECT 32000 EC*	Connection at 32000 bits/s
72	CONNECT 36000 EC*	Connection at 36000 bits/s
74	CONNECT 40000 EC*	Connection at 40000 bits/s
76	CONNECT 44000 EC*	Connection at 44000 bits/s
78	CONNECT 48000 EC*	Connection at 48000 bits/s
80	CONNECT 52000 EC*	Connection at 52000 bits/s
82	CONNECT 56000 EC*	Connection at 56000 bits/s
100	CONNECT 28000 EC*	Connection at 28000 bits/s
101	CONNECT 29333 EC*	Connection at 29333 bits/s
102	CONNECT 30666 EC*	Connection at 30666 bits/s
103	CONNECT 33333 EC*	Connection at 33333 bits/s
104	CONNECT 34666 EC*	Connection at 34666 bits/s
105	CONNECT 37333 EC*	Connection at 37333 bits/s
106	CONNECT 38666 EC*	Connection at 38666 bits/s
107	CONNECT 41333 EC*	Connection at 41333 bits/s
108	CONNECT 42666 EC*	Connection at 42666 bits/s
109	CONNECT 45333 EC*	Connection at 45333 bits/s
110	CONNECT 46666 EC*	Connection at 46666 bits/s
111	CONNECT 49333 EC*	Connection at 49333 bits/s
112	CONNECT 50666 EC*	Connection at 50666 bits/s
113	CONNECT 53333 EC*	Connection at 53333 bits/s
114	CONNECT 54666 EC*	Connection at 54666 bits/s

*EC stands for the Error Control method, which appears only when the extended result codes configuration option is enabled. EC is replaced by one of the following symbols, depending on the error control method used.

V42bis	V.42 error control and V.42bis data compression
V42	V.42 error control only
NoEC	No error control protocol

AT Command

-V90=*	V.90 Dial Line Rate
	-V90 sets the maximum V.90 downstream that the modem attempts to connect
-V90=0	V.90 disabled
-V90=1	V.90 enabled: automatic speed selection - maximum modem speed(default)

Appendix D

Wireless LAN

This appendix is intended to help you get your Wireless LAN network up and running, with a minimum of parameters.

Card Specifications

Form Factor	Mini Card
Compatibility	<ul style="list-style-type: none"> ■ IEEE 802.11 Standard for Wireless LANs ■ Wi-Fi (Wireless Fidelity) certified by the Wi-Fi Alliance. The 'Wi-Fi CERTIFIED' logo is a certification mark of the Wi-Fi Alliance.
Network Operating System	<ul style="list-style-type: none"> ■ Microsoft Windows® Networking
Media Access Protocol	<ul style="list-style-type: none"> ■ CSMA/CA (Collision Avoidance) with Acknowledgment (ACK)
Data Rate	<ul style="list-style-type: none"> ■ 54/48/36/24/18/9/6 Mb/s (Revision A and G) ■ 11/5.5/2/1 Mb/s (Revision B)

Radio Characteristics

Radio Characteristics of Wireless LAN Cards may vary according to:

- Country/region where the product was purchased
- Type of product

Wireless communication is often subject to local radio regulations. Although Wireless LAN wireless networking products have been designed for operation in the license-free 2.4GHz and 5GHz band, local radio regulations may impose a number of limitations to the use of wireless communication equipment.



Refer to the sheet "Information to the User" for regulatory information that may apply in your country/region.

R-F Frequency

- Band 5 GHz (5150-5850 MHz) (Revision A, draft N)
- Band 2.4 GHz (2400-2483.5 MHz) (Revision B, G, draft N)

The range of the wireless signal is related to the transmit rate of the wireless communication. Communications at lower transmit range may travel larger distances.

- The range of your wireless devices can be affected when the antennas are placed near metal surfaces and solid high-density materials.
- Range is also impacted due to "obstacles" in the signal path of the radio that may either absorb or reflect the radio signal.

Supported Frequency Sub-bands

Subject to the radio regulations that apply in the countries/regions, your Wireless LAN card may support a different set of 5 GHz/2.4 GHz channels. Consult your Authorized Wireless LAN or TOSHIBA Sales office for information about the radio regulations that apply in the countries/regions.

Table Wireless IEEE 802.11 Channels Sets (Revision B and G)

Frequency Range Channel ID	2400-2483.5 MHz
1	2412
2	2417
3	2422
4	2427
5	2432
6	2437
7	2442
8	2447
9	2452
10	2457 *1
11	2462
12	2467 *2
13	2472 *2

When installing Wireless LAN cards, the channel configuration is managed as follows:

- For wireless clients that operate in a Wireless LAN infrastructure, the Wireless LAN card will automatically start operation at the channel identified by the Wireless LAN Access Point. When roaming between different access points the station can dynamically switch to another channel if required.
- In a Wireless LAN Access Point, the Wireless LAN card will use the factory-set default channel (printed in bold), unless the LAN Administrator selected a different channel when configuring the Wireless LAN Access Point device.

Table Wireless IEEE 802.11 Channels Sets (Revision A)

Frequency Range Channel ID	5150-5850 MHz	Note
36	5180	
40	5200	
44	5220	
48	5240	
52	5260	
56	5280	
60	5300	
64	5320	
100	5500 ^{*3}	
104	5520 ^{*3}	
108	5540 ^{*3}	
112	5560 ^{*3}	
116	5580 ^{*3}	
120	5600 ^{*3}	
124	5620 ^{*3}	
128	5640 ^{*3}	
132	5660 ^{*3}	
136	5680 ^{*3}	
140	5700 ^{*3}	
149	5745 ^{*3}	US only ^{*4}
153	5765 ^{*3}	US only ^{*4}
157	5785 ^{*3}	US only ^{*4}
161	5805 ^{*3}	US only ^{*4}

-
- *1 Factory-set default channels
 - *2 Refer to the sheet Approved Countries/Regions for use for the countries/regions that in which these channels can be used.
 - *3 These channels are available to A/B/G combo type only.
 - *4 Available Area: US (USA, CANADA) only.

Appendix E

AC Power Cord and Connectors

The AC input plug of power cord must be compatible with various international AC power outlets. Power cords need to meet the local standards and the specifications listed as below:

Length:	Minimum 1.7 meters
Wire size:	Minimum 0.75 mm ²
Current rating:	Minimum 2.5 amperes
Voltage rating:	125 or 250 VAC (depending on country/region's power standards)

Certification agencies

Europe:

Austria:	OVE	Italy:	IMQ
Belgium:	CEBEC	The Netherlands:	KEMA
Denmark:	DEMKO	Norway:	NEMKO
Finland:	FIMKO	Sweden:	SEMKO
France:	LCIE	Switzerland:	SEV
Germany:	VDE	United Kingdom:	BSI

Outside of Europe:

U.S. and Canada:	UL listed and CSA certified No. 18 AWG, Type SVT or SPT-2		
China:	CCC, CQC	India:	STQC
Australia:	AS		

In Europe, two conductors power cord must be VDE type, H05VVH2-F or H03VVH2-F and for three conductors power cord must be VDE type, H05VV-F.

For the United States and Canada, two pin plug configuration must be a 2-15P (250V) or 1-15P (125V) and three pin plug configuration must be 6-15P (250V) or 5-15P (125V) as designated in the U.S. National Electrical code handbook and the Canadian Electrical Code Part II.

The following illustrations show the plug shapes for USA, Australia, Canada, United Kingdom, Europe, and China.

USA

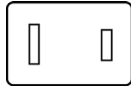

United Kingdom

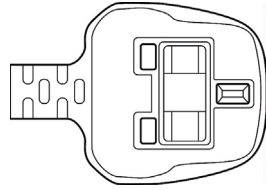

Australia

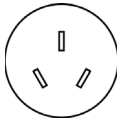

Europe

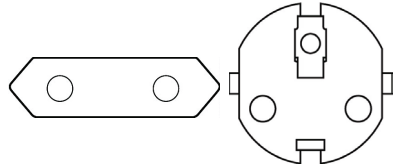

Canada



China

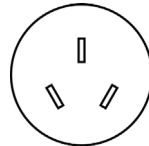

Glossary

The terms in this glossary cover topics related to this manual. Alternate naming is included for reference.

Abbreviations

AACS: advanced access content system

AC: Alternating current

ACPI: Advanced Configuration and Power Interface

ASCII: American Standard Code for Information Interchange

BIOS: basic input/output system

bps: bits per second

CD: compact disc

CD-ROM: Compact Disc Read-Only Memory

CD-RW: Compact Disc-ReWritable

CMOS: complementary metal-oxide semiconductor

CPU: central processing unit

CRT: cathode ray tube

DC: direct current

DDC: display data channel

DDR: double data rate

DIMM: dual inline memory module

DVD: digital versatile disc

DVD-R: Digital Versatile Disc Recordable

DVD-RAM: Digital Versatile Disc Random Access Memory

DVD-R (Dual Layer): Digital Versatile Disc Recordable Dual Layer

DVD-ROM: Digital Versatile Disc Read Only Memory

DVD-RW: Digital Versatile Disc ReWritable

DVD+R (Double Layer): Digital Versatile Disc Recordable Double Layer

FDD: floppy diskette drive

FHD: Full High Definition

FIR: fast infrared

GB: gigabyte

HDD: hard disk drive

HD+: High Definition Plus

IDE: integrated drive electronics
IEEE: Institute of Electrical and Electronics Engineers
I/O: input/output
IrDA: Infrared Data Association
IRQ: interrupt request
KB: kilobyte
LAN: local area network
LCD: liquid crystal display
LED: light emitting diode
MB: megabyte
MMC: multi media card
OCR: optical character recognition (reader)
PCB: printed circuit board
PCI: peripheral component interconnect
RAM: random access memory
RGB: red, green, and blue
ROM: read only memory
RTC: real time clock
S/P DIF: Sony/Philips Digital Interface Format
SDRAM: synchronous dynamic random access memory
SLI: Scalable Link Interface
SO-DIMM: small-outline dual in line memory module
TFT: thin-film transistor
UART: universal asynchronous receiver/transmitter
USB: Universal Serial Bus
VESA: Video Electronic Standards Association
VGA: video graphics array
XGA: extended graphics array

A

adaptor: A device that provides a compatible connection between two units. For example, the computer's internal display adapter receives information from the software and translates it into images on the screen. An adapter can take a number of forms, from a microprocessor to a simple connector: An intelligent adapter (one that is capable of doing some processing) may also be called a controller.

alphanumeric: Keyboard characters including letters, numbers and other symbols, such as punctuation marks or mathematical symbols.

alternating current (AC): Electric current that reverses its direction of flow at regular intervals.

- analog signal:** A signal whose characteristics such as amplitude and frequency vary in proportion to (are an analog of) the value to be transmitted. Voice communications are analog signals.
- application:** A group of programs that together are used for a specific task such as accounting, financial planning, spreadsheets, word processing and games.
- ASCII:** American Standard Code for Information Interchange. ASCII code is a set of 256 binary codes that represent the most commonly used letters, numbers, and symbols.
- asynchronous:** Lacking regular time relationship. As applied to computer communications, asynchronous refers to the method of transmitting data that does not require a steady stream of bits to be transmitted at regular time intervals.

B

- backup:** A copy of a file, usually on a removable disk, kept in case the original file is lost or damaged.
- binary:** The base two number system composed of zeros and ones (off or on), used by most digital computers. The right-most digit of a binary number has a value of 1, the next a value of 2, then 4, 8, 16, and so on. For example, the binary number 101 has a value of 5. See also ASCII.
- BIOS:** Basic Input/Output System. The firmware that controls data flow within the computer. See also firmware.
- bit:** Derived from "binary digit," the basic unit of information used by the computer. It is either zero or one. Eight bits is one byte. See also byte.
- Bluetooth:** A short-range radio technology designed to simplify wireless communication among computers, communication devices and the Internet.
- board:** A circuit board. An internal card containing electronic components, called chips, which perform a specific function or increase the capabilities of the system.
- boot:** Short for bootstrap. A program that starts or restarts the computer. The program reads instructions from a storage device into the computer's memory.
- boot disk:** See system disk.
- bootable disk:** See system disk.
- bps:** Bits per second. Typically used to describe the data transmission speed of a modem.
- buffer:** The portion of the computer's memory where data is temporarily stored. Buffers often compensate for differences in the rate of flow from one device to another.
- bus:** An interface for transmission of signals, data or electric power.

byte: The representation of a single character. A sequence of eight bits treated as a single unit; also the smallest addressable unit within the system.

C

cache memory: A section of very fast memory in which frequently used information is duplicated for quick access. Accessing data from cache is faster than accessing it from the computer's main memory. See also L1 cache, L2 cache.

capacity: The amount of data that can be stored on a magnetic storage device such as a floppy diskette or hard disk drive. It is usually described in terms of kilobytes (KB), where one KB = 1024 bytes, megabytes (MB), where one MB = 1024 KB and gigabytes (GB), where one GB = 1024 MB.

CD: An individual compact disc. See also CD-ROM.

CD-R: A Compact Disc-Recordable disc can be written once and read many times. See also CD-ROM.

CD-ROM: A Compact Disc Read-Only Memory is a high capacity disc that can be read from but not written to. The CD-ROM drive uses a laser, rather than magnetic heads, to read data from the disc.

CD-RW: A Compact Disc-ReWritable disc can be rewritten many times. See also CD-ROM.

character: Any letter, number, punctuation mark, or symbol used by the computer. Also synonymous with byte.

chassis: The frame containing the computer.

chip: A small semiconductor containing computer logic and circuitry for processing, memory, input/output functions and controlling other chips.

click: To press and release the pointing device's primary button without moving the pointing device. In the Windows® operating system, this refers to the pointing device's left button, unless otherwise stated. See also double-click.

CMOS: Complementary Metal-Oxide Semiconductor. An electronic circuit fabricated on a silicon wafer that requires very little power. Integrated circuits implemented in CMOS technology can be tightly packaged and are highly reliable.

cold start: Starting a computer that is currently off (turning on the power).

COM1, COM2, COM3 and COM4: The names assigned to the serial and communication ports.

commands: Instructions you enter at the terminal keyboard that direct the actions of the computer or its peripheral devices.

compatibility: 1) The ability of one computer to accept and process data in the same manner as another computer without modifying the data or the media upon which it is being transferred. 2) the ability of one device to connect to or communicate with another system or component.

- components:** Elements or parts (of a system) which make up the whole (system).
- Composite Video (YUV):** A standard video signal used to transmit images, e.g. from a VCR to a TV.
- computer program:** A set of instructions written for a computer that enable it to achieve a desired result.
- computer system:** A combination of hardware, software, firmware, and peripheral components assembled to process data into useful information.
- configuration:** The specific components in your system (such as the terminal, printer, and disk drives) and the settings that define how your system works. You use the HW Setup program to control your system configuration.
- controller:** Built-in hardware and software that controls the functions of a specific internal or peripheral device (e.g. keyboard controller).
- co-processor:** A circuit built into the processor that is dedicated to intensive math calculations.
- CPU:** Central Processing Unit. The portion of the computer that interprets and executes instructions.
- CRT:** Cathode Ray Tube. A vacuum tube in which beams projected on a fluorescent screen-producing luminous spots. An example is the television set.
- cursor:** A small, blinking rectangle or line that indicates the current position on the display screen.

D

- data:** Information that is factual, measurable or statistical that a computer can process, store, or retrieve.
- data bits:** A data communications parameter controlling the number of bits (binary digits) used to make up a byte. If data bits = 7 the computer can generate 128 unique characters. If data bits = 8 the computer can generate 256 unique characters.
- DC:** Direct Current. Electric current that flows in one direction. This type of power is usually supplied by batteries.
- default:** The parameter value automatically selected by the system when you or the program do not provide instructions. Also called a preset value.
- delete:** To remove data from a disk or other data storage device. Synonymous with erase.
- device driver:** A program (called a "driver") that permits a computer to communicate with a device.
- dialog box:** A window that accepts user input to make system settings or record other information.
- disable:** To turn a computer option off. See also enable.

- Digital Audio:** An audio compression standard that enables high-quality transmission and real-time playback of sound files.
- disk drive:** The device that randomly accesses information on a disk and copies it to the computer's memory. It also writes data from memory to the disk. To accomplish these tasks, the unit physically rotates the disk at high speed past a read-write head.
- disk storage:** Storing data on magnetic disk. Data is arranged on concentric tracks much like a phonograph record.
- display:** A CRT, LCD, or other image producing device used to view computer output.
- documentation:** The set of manuals and/or other instructions written for the users of a computer system or application. Computer system documentation typically includes procedural and tutorial information as well as system functions.
- double click:** To press and release the pointing device's primary button rapidly twice without moving the pointing device. In the Windows® operating system, this refers to the pointing device's left button, unless otherwise stated.
- driver:** A software program, generally part of the operating system, that controls a specific piece of hardware (frequently a peripheral device such as a printer or mouse).
- DVD:** An individual digital versatile (or video) disc. See also DVD-ROM.
- DVB-T (Digital Video Broadcasting - Terrestrial):** Also known as terrestrial digital TV. Digital TV broadcasting standard.
- DVD-R (+R, -R):** A Digital Versatile Disc Recordable disc can be written once and read many times. The DVD-R drive uses a laser to read data from the disc.
- DVD-RAM:** A Digital Versatile Disc-Random Access Memory is a highcapacity, high performance disc that lets you store large volumes of data. The DVD-RAM drive uses a laser to read data from the disc.
- DVD-R (Dual Layer):** A disc having two layers on one side with the DVD-R storage capacity about 1.8 times larger than before. The DVD-RW drive uses a laser to read data from the disc.
- DVD-ROM:** A Digital Versatile Disc-Read Only Memory is a high capacity, high performance disc suitable for play back of video and other high-density files. The DVD-ROM drive uses a laser to read data from the disc.
- DVD-RW (+RW, -RW):** A Digital Versatile Disc-ReWritable disc can be rewritten many times.
- DVD+R (Double Layer):** A disc having two layers on one side with the DVD+R storage capacity about 1.8 times larger than before. The DVD-RW drive uses a laser to read data from the disc.

E

echo: To send back a reflection of the transmitted data to the sending device. You can display the information on the screen, or output it to the printer, or both. When a computer receives back data it transmitted to a CRT (or other peripheral device) and then transmits the data to printer, the printer is said to echo the CRT.

enable: To turn on a computer option. See also disable.

erase: See delete.

escape: 1) A code (ASCII code 27), signaling the computer that what follows are commands; used with peripheral devices such as printers and modems. 2) A means of aborting the task currently in progress.

escape guard time: A time before and after an escape code is sent to the modem which distinguishes between escapes that are part of the transmitted data, and escapes that are intended as a command to the modem.

execute: To interpret and execute an instruction.

F

fast infrared: An industry standard that enables cableless infrared serial data transfer at speeds of up to 4 Mbps.

file: A collection of related information; a file can contain data, programs, or both.

fingerprint sensor: The fingerprint sensor compares and analyzes the unique characteristics in a fingerprint.

firmware: A set of instructions built into the hardware which controls and directs a microprocessor's activities.

flash memory: Non-volatile memory that can be written to as well as read. Information in flash memory remains whether or not the computer is receiving power. This type of memory is used to retain your fingerprint data. See also memory. Compare RAM and ROM.

floppy diskette: A removable disk that stores magnetically encoded data.

floppy diskette drive (FDD): An electromechanical device that reads and writes to floppy diskettes.

Fn-esse: A TOSHIBA utility that lets you assign functions to hot keys.

folder: An icon in Windows used to store documents or other folders.

format: The process of readying a blank disk for its first use. Formatting establishes the structure of the disk that the operating system expects before it writes files or programs onto the disk.

function keys: The keys labeled **F1** through **F9** that tell the computer to perform certain functions.

G

gigabyte (GB): A unit of data storage equal to 1024 megabytes. See also megabyte.

graphics: Drawings, pictures, or other images, such as charts or graphs, to present information.

H

hard disk: A storage device composed of a rigid platter or platters that can be magnetically coded with data. Hard disks hold much more information than diskettes and are used for long-term storage of programs and data. The primary (or only) hard disk in a computer is usually fixed, but some computers have secondary hard disks that are removable. By default, the hard disk is referred to as drive C.

hard disk drive (HDD): An electromechanical device that reads and writes a hard disk. See also hard disk.

hardware: The physical electronic and mechanical components of a computer system: typically, the computer itself, external disk drives, etc. See also software and firmware.

hertz: A unit of wave frequency that equals one cycle per second.

host computer: The computer that controls, regulates, and transmits information to a device or another computer.

hot key: The computer's feature in which certain keys in combination with the extended function key, **FN**, can be used to set system parameters, such as speaker volume.

HW Setup: A TOSHIBA utility that lets you set the parameters for various hardware components.

I

icon: A small graphic image displayed on the screen or in the indicator panel. In Windows, an icon represents an object that the user can manipulate.

i.LINK (IEEE1394): This port enables high-speed data transfer directly from external devices such as digital video cameras.

input: The data or instructions you provide to a computer, communication device or other peripheral device from the keyboard or external or internal storage devices. The data sent (or output) by the sending computer is input for the receiving computer.

instruction: Statements or commands that specify how to perform a particular task.

interface: 1) Hardware and/or software components of a system used specifically to connect one system or device to another. 2) To physically connect one system or device to another to exchange information. 3) The point of contact between user, the computer, and the program, for example, the keyboard or a menu.

interrupt request: A signal that gives a component access to the processor.

I/O: Input/output. Refers to acceptance and transfer of data to and from a computer.

I/O devices: Equipment used to communicate with the computer and transfer data to and from it.

IrDA 1.1: An industry standard that enables cableless infrared serial data transfer at speeds of up to 4 Mbps.

K

K: Taken from the Greek word kilo, meaning 1000; often used as equivalent to 1024, or 2 raised to the 10th power. See also byte and kilobyte.

keyboard: An input device containing switches that are activated by manually pressing marked keys. Each keystroke activates a switch that transmits a specific code to the computer. For each key, the transmitted code is, in turn, representative of the (ASCII) character marked on the key.

kilobyte (KB): A unit of data storage equal to 1024 bytes. See also byte and megabyte.

L

L1 cache: Level one cache. Memory cache built into the processor to help improve processing speed. See also cache memory, L2 cache.

L2 cache: Memory cache installed on the motherboard to help improve processing speed. It is slower than L1 cache and faster than main memory. See also cache memory, L1 cache.

LAN: A group of computers or other devices dispersed over a relatively limited area and connected by a communications link that enables any device to interact with any other on the network.

Light Emitting Diode (LED): A semiconductor device that emits light when a current is applied.

Liquid Crystal Display (LCD): Liquid crystal sealed between two sheets of glass coated with transparent conducting material. The viewingside coating is etched into character forming segments with leads that extend to the edge of the glass. Applying a voltage between the glass sheets alters the brightness of the liquid crystal.

M

main board: See motherboard.

megabyte (MB): A unit of data storage equal to 1024 kilobytes. See also kilobyte.

megahertz: A unit of wave frequency that equals 1 million cycles per second. See also hertz.

- memory:** Typically refers to the computer's main memory, where programs are run and data is temporarily stored and processed. Memory can be volatile and hold data temporarily, such as RAM, or it can be nonvolatile and hold data permanently, such as ROM. A computer's main memory is RAM. See RAM, ROM.
- menu:** A software interface that displays a list of options on the screen. Also called a screen.
- microprocessor:** A hardware component contained in a single integrated circuit that carries out instructions. Also called the central processing unit (CPU), one of the main parts of the computer.
- mode:** A method of operation, for example, the Shut Down Mode, Sleep Mode or the Hibernation Mode.
- modem:** Derived from modulator/demodulator, a device that converts (modulates) digital data for transmission over telephone lines and then converts modulated data (demodulates) to digital format where received.
- monitor:** A device that uses rows and columns of pixels to display alphanumeric characters or graphic images. See also CRT.
- motherboard:** A name sometimes used to refer to the main printed circuit board in processing equipment. It usually contains integrated circuits that perform the processor's basic functions and provides connectors for adding other boards that perform special functions.
- MP3:** An audio compression standard that enables high-quality transmission and real-time playback of sound files.

N

- network:** A collection of computers and associated devices that are connected by communications facilities. A network allows you to share data and peripheral devices, such as printers, with other users and to exchange electronic mail.
- non-system disk:** A disk for storing programs and data that cannot be used to start the computer. Compare system disk.
- nonvolatile memory:** Memory, usually read-only (ROM), that is capable of permanently storing information. Turning the computer's power off does not alter data stored in nonvolatile memory.
- numeric keypad overlay:** A feature that allows you to use certain keys on the keyboard to perform numeric entry, or to control cursor and page movement.

O

- OCR:** Optical Character Recognition (reader). A technique or device that uses laser or visible light to identify characters and input them into a storage device.
- online state:** A functional state of a peripheral device when it is ready to receive or transmit data.

operating system: A group of programs that controls the basic operation of a computer. Operating system functions include interpreting programs, creating data files, and controlling the transmission and receipt (input/output) of data to and from memory and peripheral device.

output: The results of a computer operation. Output commonly indicates data. 1) printed on paper, 2) displayed at a terminal, 3) sent through the serial port of internal modem, or 4) stored on some magnetic media.

P

PAL: PAL (Phase Alternating Line) is the dominant video and broadcasting standard in Europe.

parity: 1) The symmetrical relationship between two parameter values (integers) both of which are either on or off; odd or even; 0 or 1. 2) In serial communications, an error detection bit that is added to a group of data bits making the sum of the bits even or odd. Parity can be set to none, odd, or even.

password: A unique string of characters used to identify a specific user. The computer provides various levels of password protection such as user and supervisor.

PCI: Peripheral Component Interconnect. An industry standard 32-bit bus.

peripheral: Any device, such as a printer or joystick, that is attached to the computer and controlled by the computer's CPU.

Péritel: Péritel is a 21-pin connecting cable/port system that allows images and high-quality stereo sound (including Dolby® Pro-Logic sound formats) to be sent from one audio-visual device to another. It is also known as a "SCART connector" or "Euro connector".

pixel: A picture element. The smallest dot that can be made on a display or printer. Also called a pel.

plug and play: A capability with Windows that enables the system to automatically recognize connections of external devices and make the necessary configurations in the computer.

pointing device: Any device, such as the TouchPad or a mouse, that enables you to move the cursor on the screen.

port: The electrical connection through which the computer sends and receives data to and from devices or other computers.

Power Saver: A TOSHIBA utility that lets you set the parameters for various power-saving functions.

program: A set of instructions a computer can execute that enables it to achieve a desired result. See also application.

prompt: A message the computer provides indicating it is ready for or requires information or an action from you.

R

Radio frequency interference (RFI) shield: A metal shield enclosing the printed circuit boards of the printer or computer to prevent radio and TV interference. All computer equipment generates radio frequency signals. The FCC regulates the amount of signals a computing device can allow past its shielding. A Class A device is sufficient for office use. Class B provides a more stringent classification for home equipment use. TOSHIBA portable computers comply with Class B computing device regulations.

Random Access Memory (RAM): Volatile memory that can be written to as well as read. Volatile here means that information in RAM is lost when you turn off your computer. This type of memory is used for your computer's main memory. See also memory. Compare ROM.

resolution: A measure of the sharpness of the images that can be produced by a printer or displayed on a screen. For a printer, resolution is expressed in dots per inch (dpi). For a screen, it is expressed as the number of pixels available horizontally and vertically

restart: Resetting a computer without turning it off (also called "warm boot", "soft reset" or "reboot"). See also boot.

RGB: Red, green and blue. A device that uses three input signals, each activating an electron gun for a primary additive color (red, green and blue) or port for using such a device. See also CRT.

RJ11: A modular telephone jack.

RJ45: A modular LAN jack.

Read Only Memory (ROM): Non-volatile memory that can be read but not written to. Non-volatile here means that information in ROM remains whether or not the computer is receiving power. This type of memory is used to store your computer's BIOS, which is essential instructions the computer reads when you start it up. See also BIOS, memory. Compare RAM.

S

S/P DIF: A standard of digital interface for audio.

SCSI: Small Computer System Interface is an industry standard interface for connection of a variety of peripheral devices.

SD/SDHC memory card: Secure Digital cards are flash memory widely used in a variety of digital devices such as digital cameras and Personal Digital Assistants.

SECAM L: SECAM (Sequential Color Memory) is a broadcasting standard used in France.

SIO: Serial Input/Output. The electronic methodology used in serial data transmission.

- soft key:** Key combinations that emulate keys on the IBM keyboard, change some configuration options, stop program execution, and access the numeric keypad overlay.
- software:** The set of programs, procedures and related documentation associated with a computer system. Specifically refers to computer programs that direct and control the computer system's activities. See *also* hardware.
- stop bit:** One or more bits of a byte that follow the transmitted character or group codes in asynchronous serial communications.
- synchronous:** Having a constant time interval between successive bits, characters or events.
- system disk:** A diskette that contains the operating system files needed to start the computer. Any diskette can be formatted as a system disk. A system disk is also called a "bootable disk", "boot disk" or a "startup disk." Compare non-system disk.

T

- terminal:** A typewriter-like keyboard and CRT display screen connected to the computer for data input/output.
- TFT display:** A liquid crystal display (LCD) made from an array of liquid crystal cells using active-matrix technology with thin film transistor (TFT) to drive each cell.
- Touch Pad:** A pointing device integrated into the TOSHIBA computer palm rest.

U

- USB:** Universal Serial Bus. This serial interface lets you communicate with several devices connected in a chain to a single port on the computer.

V

- VGA:** Video Graphics Array is an industry standard video adaptor that lets you run any popular software.
- volatile memory:** Random access memory (RAM) that stores information as long as power is supplied to the computer.

W

- warm start:** Restarting or resetting a computer without turning it off.
- Wi-Fi®:** A registered trademark term of the Wi-Fi Alliance that stands for Wireless Fidelity, and is another term for the communication protocol to permit an Ethernet connection using wireless communication components.

- window:** A portion of the screen that can display its own application, document or dialog box. Often used to mean a Microsoft Windows window.
- Wireless LAN:** Local Area Network (LAN) through wireless communication.
- write protection:** A method for protecting a floppy diskette from accidental erasure.

A

- AC adaptor, 1-6
 - additional, 1-17
 - connecting, 3-2
 - DC IN 19V jack, 2-6
- ASCII characters, 5-7

B

- Battery
 - charging, 6-5
 - extending battery life, 6-8
 - indicator, 2-12, 6-2
 - Monitoring capacity, 6-7
 - real time clock, 1-5, 6-4
 - save mode, 1-12
 - types, 6-3
- Battery Charger, 8-11
- Battery pack, 1-5, 2-8
 - additional, 8-11
 - replacing, 6-9
- Bluetooth, 1-8, 4-39
 - Bluetooth Stack for Windows by Toshiba, 1-14
 - problems, 9-23
- Bridge media slot, 1-6, 2-2, 8-3
 - indicator, 2-12
 - using, 8-3

C

- Cache memory, 1-3
- Cleaning the computer, 4-43
- Connecting the i.LINK (IEEE1394) cable, 8-20
- Cooling vents, 2-3, 2-8

D

- DC IN indicator, 2-12, 6-3
- Disconnecting the i.LINK (IEEE1394) cable, 8-20
- Display, 2-8
 - automatic power off, 1-11
 - brightness (down), 5-4
 - brightness (up), 5-4
 - controller, B-1
 - hinge, 2-9
 - opening, 3-5

Documentation list, 1-2

E

Equipment checklist, 1-1

ExpressCard, 1-6, 8-2

 inserting, 8-2

 problems, 9-11

 removing, 8-3

External monitor, 1-6, 2-3, 8-15

 problems, 9-20

F

Fingerprint Sensor

 problems, 9-16

FN + 1 (TOSHIBA Zooming Utility reduce), 5-5

FN + 2 (TOSHIBA Zooming Utility enlarge), 5-5

FN + ENTER, 5-3

FN + ESC (Mute), 5-3

FN + F1 (Lock), 5-3

FN + F10 (Arrow mode), 5-6

FN + F11 (Numeric mode), 5-6

FN + F12 (ScrLock), 5-3

FN + F2 (Power Plan), 5-3

FN + F3 (Sleep), 5-4

FN + F4 (Hibernate), 5-4

FN + F5 (Output), 5-4

FN + F6 (Brightness Down), 5-4

FN + F7 (Brightness Up), 5-4

FN + F8 (Wireless), 5-4

FN + F9 (Touch Pad), 5-4

FN + space (Zoom), 5-5

Front operation panel, 4-14

Function keys, 5-2

H

Hard disk drive

 automatic power off, 1-11

HDMI, 8-15

Heat dispersal, 1-12

Hibernation Mode, 1-12

Hot keys, 1-11

 Brightness (Down), 5-4

 Brightness (Up), 5-4

 Hibernate, 5-4

- Lock, 5-3
- Mute, 5-3
- Output, 5-4
- Power Plan, 5-3
- Sleep, 5-4
- TOSHIBA Zooming Utility (enlarge), 5-5
- TOSHIBA Zooming Utility (reduce), 5-5
- Touch Pad, 5-4
- Wireless, 5-4
- Zoom, 5-5

HW Setup

- accessing, 7-1
- general, 7-2

HW Setup utility, 1-15

I

i.LINK, 1-6, 2-5, 8-19

- precautions, 8-19
- problems, 9-24

Indicators

- Battery, 2-12, 6-2
- DC IN, 2-12
- HDD/ODD/eSATA, 2-12
- Power, 2-12

Infrared receiver window, 1-8

- problems, 9-13

K

Keyboard, 1-6, 5-1

- emulating keys on enhanced, 5-2
- FN Sticky key, 5-5
- Function keys F1 ... F12, 5-2
- Hot keys, 5-3
- problems, 9-7
- Typewriter keys, 5-1
- Windows special keys, 5-5

Keypad overlay, 1-12, 5-6

- arrow mode, 5-6
- numeric mode, 5-6
- temporarily using normal keyboard (overlay on), 5-7
- temporarily using overlay (overlay off), 5-7
- turning on the overlays, 5-6

L

- LAN, 1-8, 4-41
 - cable types, 4-41
 - connecting, 4-42
 - disconnecting, 4-42
 - jack, 2-4
 - problems, 9-22

M

- Media care, 4-26
 - CD/DVDs, 4-26
- Memory, 1-3
 - expansion, 1-17
 - installing, 8-8
 - removing, 8-10
- Modem, 1-8, 4-34
 - connecting, 4-36
 - disconnecting, 4-37
 - jack, 2-6
 - problems, 9-21
 - properties menu, 4-35
 - region selection, 4-35
- Moving the computer, 4-44
- MultiMediaCard
 - problems, 9-13

P

- Password
 - power on, 1-12
 - problems, 9-7
 - user, 6-12
- Pointing device
 - Touch Pad, 2-9, 4-1
- Ports, 1-6
 - External monitor, 1-6
 - i.LINK, 1-6
 - USB, 1-6
- Power
 - conditions, 6-1
 - Hibernation Mode, 3-8
 - indicator, 6-3
 - panel power on/off, 6-13
 - Shut Down mode (Boot Mode), 3-7

Sleep Mode, 3-9
system auto off, 6-14
turning off, 3-7
turning on, 3-6

Problems

AC power, 9-5
Analyzing the problem, 9-2
Battery, 9-6
Bluetooth, 9-23
ExpressCard, 9-11
External monitor, 9-20
Fingerprint Sensor, 9-16
Hard disk drive, 9-8
Hardware and system checklist, 9-3
HDMI Monitor, 9-23
i.LINK (IEEE1394) device, 9-24
Infrared receiver window, 9-13
Internal display panel, 9-8
Keyboard, 9-7
LAN, 9-22
Memory Stick/Memory Stick PRO/Memory Stick PRO Duo, 9-12
Modem, 9-21
MultiMediaCard, 9-13
Overheating power down, 9-5
Password, 9-7
Pointing device, 9-13
Power, 9-4
SD/SDHC memory card, miniSD/microSD Card, 9-11
Self test, 9-4
Sound system, 9-19
System start-up, 9-4
TOSHIBA support, 9-25
Touch Pad, 9-13
USB device, 9-16
USB floppy diskette drive, 9-10
USB mouse, 9-15
USB Sleep and Charge, 9-7
Video Playback, 9-24
Wireless LAN, 9-23
xD picture card, 9-12

Processor, 1-3

R

- Recovery Discs, 3-14
- Recovery hard disk drive, 3-13
- Restarting the computer, 3-11

S

- SD/SDHC memory card, miniSD/microSD Card
 - problems, 9-11
- Security lock
 - attaching, 8-21
- Sleep Mode, 1-13
 - setting, 3-9
 - System automatic, 1-11
- Soft keys
 - emulating keys on enhanced keyboard, 5-2
 - ENTER, 5-3
 - ScrLock, 5-3
- Sound system, 1-7, 4-27
 - Headphone (S/PDIF) jack, 1-7, 2-3
 - microphone, 2-11
 - microphone jack, 1-7, 2-2
 - Stereo speakers, 2-9
 - Volume control, 2-3

T

- TOSHIBA Assist, 1-15
- TOSHIBA ConfigFree, 1-15
- TOSHIBA Disc Creator, 1-15, 4-19
- TOSHIBA PC Diagnostic Tool, 1-13
- TOSHIBA support, 9-25
- TOSHIBA Zooming Utility, 1-13
- Touch Pad, 1-5
 - using, 4-1

U

- USB device, 1-6
 - problems, 9-16
- USB floppy diskette drive, 8-11
 - problems, 9-10
 - using, 8-12

V

- Video RAM, 1-4

Volume control, 2-3

W

Web Camera, 1-7

Wireless communication, 4-38
indicator, 4-41

Wireless communication switch, 1-9, 2-1, 4-40

Wireless LAN, 1-8, 4-38
problems, 9-23

X

xD picture card
problems, 9-12